

**Road Planning and Design Manual  
Edition 2: Volume 3**

**Supplement to Austroads Guide to Road Design  
Part 4C: Interchanges**

**November 2020**

## Copyright

© The State of Queensland (Department of Transport and Main Roads) 2020.

## Licence



This work is licensed by the State of Queensland (Department of Transport and Main Roads) under a Creative Commons Attribution (CC BY) 4.0 International licence.

## CC BY licence summary statement

In essence, you are free to copy, communicate and adapt this work, as long as you attribute the work to the State of Queensland (Department of Transport and Main Roads). To view a copy of this licence, visit: <https://creativecommons.org/licenses/by/4.0/>

## Translating and interpreting assistance



The Queensland Government is committed to providing accessible services to Queenslanders from all cultural and linguistic backgrounds. If you have difficulty understanding this publication and need a translator, please call the Translating and Interpreting Service (TIS National) on 13 14 50 and ask them to telephone the Queensland Department of Transport and Main Roads on 13 74 68.

## Disclaimer

While every care has been taken in preparing this publication, the State of Queensland accepts no responsibility for decisions or actions taken as a result of any data, information, statement or advice, expressed or implied, contained within. To the best of our knowledge, the content was correct at the time of publishing.

## Feedback

Please send your feedback regarding this document to: [tmr.techdocs@tmr.qld.gov.au](mailto:tmr.techdocs@tmr.qld.gov.au)

## Relationship with Austroads Guide to Road Design – Part 4C (2015)

The Department of Transport and Main Roads has, in principle, agreed to adopt the standards published in the *Austroads Guide to Road Design (2015) Part 4C: Interchanges*.

When reference is made to other parts of the *Austroads Guide to Road Design* or the *Austroads Guide to Traffic Management*, the reader should also refer to Transport and Main Roads related manuals:

- *Road Planning and Design Manual (RPDM)*
- *Traffic and Road Use Management Manual (TRUM)*.

Where a section does not appear in the body of this supplement, the *Austroads Guide to Road Design – Part 4C* criteria is accepted unamended.

This supplement:

1. has precedence over the *Austroads Guide to Road Design – Part 4C* when applied in Queensland
2. details additional requirements, including *accepted with amendments* (additions or differences), *new* or *not accepted*.
3. has the same structure (section numbering, headings and contents) as *Austroads Guide to Road Design – Part 4C*.

The following table summarises the relationship between the *Austroads Guide to Road Design – Part 4C* and this supplement using the following criteria:

Accepted	Where a section does not appear in the body of this supplement, the <i>Austroads Guide to Road Design – Part 4C</i> is accepted.
Accepted with amendments	Part or all of the section has been accepted with additions and/or differences.
New	There is no equivalent section in the <i>Austroads Guide</i> .
Not accepted	The section of the <i>Austroads Guide</i> is not accepted.

Austroads Guide to Road Design – Part 4C	RPDM relationship
<b><u>1 Introduction</u></b>	
1.1 Purpose	Accepted
1.2 Scope of this Part	Accepted with amendments
1.3 Road Safety	Accepted
1.4 Road Design Objectives	Accepted
1.5 Traffic Management at Interchanges	Accepted
1.6 Safety Performance of Interchanges	Accepted
1.7 Traffic Capacity of Interchanges	Accepted
1.8 Staged Development of Interchanges	Accepted
<b><u>2 Design Considerations Process and Principles</u></b>	
2.1 General	Accepted
2.2 Design Considerations	Accepted with amendments
2.3 Design Process	Accepted

<b>Austrroads Guide to Road Design – Part 4C</b>	<b>RPDM relationship</b>
2.4 Principles	Accepted with amendments
<b><u>3 Forms of Interchange</u></b>	
3.1 Traffic Considerations	Accepted
3.2 Other Considerations	Accepted
<b><u>4 Structures</u></b>	
4.1 General	Accepted
4.2 Form of Structure	Accepted
4.3 Cross-sections on Bridges	Accepted
4.4 Pedestrian / Cyclist Grade Separations	Accepted
4.5 Culverts	Accepted
4.6 Retaining Walls	Accepted
4.7 Wildlife Crossings	Accepted
4.8 Services on Structure	Accepted
4.9 Safety Screens	Accepted with amendments
<b><u>5 Cross-Section</u></b>	
5.1 Major Road and Minor Road	Accepted
5.2 Ramp Cross-section	Accepted with amendments
5.3 Clearances on Major Road	Accepted
<b><u>6 Design Speed</u></b>	
6.1 General	Accepted
6.2 Major Road	Accepted
6.3 Minor Road	Accepted
6.4 Ramps	Accepted with amendments
<b><u>7 Sight Distance</u></b>	
7.1 General	Accepted
7.2 Stopping Sight Distance on the Major Road and Minor Road	Accepted with amendments
7.3 Exit Ramp Nose	Accepted with amendments
7.4 Entry Ramp Nose	Accepted
7.5 Safe Intersection Sight Distance	Accepted
<b><u>8 Horizontal Alignment</u></b>	
8.1 Major Road	Accepted
8.2 Minor Road	Accepted with amendments
8.3 Ramps	Accepted
<b><u>9 Vertical Alignment</u></b>	
9.1 Major Road	Accepted
9.2 Minor Road	Accepted
9.3 Ramps	Accepted

<b>Austrroads Guide to Road Design – Part 4C</b>	<b>RPDM relationship</b>
<b><u>10 Ramp Terminals at Major Roads</u></b>	
10 Ramp Terminals at Major Roads	Accepted with amendments
10.1 Ramp Terminal Locations	Accepted with amendments
10.2 Ramp Alignment at Minor Road Terminals	Accepted
10.3 Ramp Terminal at Minor Road	Accepted
<b><u>11 Ramp Terminals at the Major Road</u></b>	
11.1 General	Accepted with amendments
11.2 Exit Ramps	Accepted with amendments
11.3 Entry Ramps	Accepted with amendments
11.4 Ramp Traffic Signals	Accepted with amendments
<b><u>12 Ramps on Two-Lane Two-Way Freeways</u></b>	
12 Ramps on Two-Lane Two-Way Freeways	Accepted
<b><u>13 Pedestrians</u></b>	
13.1 General	Accepted
13.2 Bus Passengers	Accepted
<b><u>14 Cyclists</u></b>	
14.1 General	Accepted with amendments
14.2 Treatment at Interchanges	Accepted with amendments
<b><u>15 Pavement Markings, Signs and Lighting</u></b>	
15.1 General	Accepted with amendments
15.2 Key Considerations	Accepted
15.3 Lighting of Interchanges	Accepted with amendments
<b><u>16 Landscaping and Street Furniture</u></b>	
16.1 General	Accepted with amendments
16.2 Landscape Development	Accepted
16.3 Road Safety	Accepted
<b><u>17 Other Considerations</u></b>	
17.1 Access in the Vicinity of Interchanges	Accepted
17.2 Service Centres	Accepted
17.3 Oversized Loads and High Wide Load Corridors	Accepted
<b><u>18 Grade Separated Intersections and Movements</u></b>	
18.1 Grade Separated Intersections	New
18.2 Grade Separated Movements	New
<b><u>References</u></b>	
References	Accepted with amendments
<b><u>Appendices</u></b>	
Appendix A Example of Ramp Speed Analysis	Accepted
Appendix B Ramp Terminal Location	Accepted
Appendix C Examples of Ramp Signal Layouts	Accepted with amendments
Appendix D Trapped Lane Exit – EDD Treatment	New

Austroads Guide to Road Design – Part 4C	RPDM relationship
<b>Commentaries</b>	
Commentary 1	Accepted
Commentary 2	Accepted
Commentary 3	Accepted
Commentary 4	Accepted
Commentary 5	Accepted with amendments
Commentary 6	New
Commentary 7	New
Commentary 8	New

# Contents

- 1 Introduction ..... 1**
- 1.2 Scope of this part ..... 1
- 2 Design considerations process and principles ..... 1**
- 2.2 Design considerations ..... 1
  - 2.2.3 Stormwater drainage ..... 1
  - 2.2.4 Landscape development ..... 1
  - 2.4.2 Interchange uniformity and spacing ..... 1
- 4 Structures ..... 1**
- 4.9 Safety screens ..... 1
- 5 Cross-section ..... 2**
- 5.2 Ramp cross-section ..... 2
  - 5.2.1 Number of lanes on ramps ..... 2
  - 5.2.2 Ramp lane widths ..... 2
- 6 Design speed ..... 2**
- 6.4 Ramps ..... 2
  - 6.4.1 Ramp design speed ..... 2
- 7 Sight distance ..... 3**
- 7.2 Stopping sight distance on the major road and minor road ..... 3
- 7.3 Exit ramp nose ..... 4
- 8 Horizontal alignment ..... 6**
- 8.2 Minor road ..... 6
  - 8.2.1 Curvature ..... 6
- 10 Ramp terminals at major roads ..... 6**
- 11 Ramp terminals at the major road ..... 6**
- 11.1 General ..... 6
- 11.2 Exit ramps ..... 14
  - 11.2.1 Single-lane exits ..... 14
  - 11.2.2 Two-lane exits ..... 14
  - 11.2.3 Exits to two high-speed roadways ..... 15
  - 11.2.4 Lane drop at an exit ..... 17
  - 11.2.5 Exit from an arterial road ..... 18
  - 11.2.6 Exit from another ramp ..... 18
- 11.3 Entry ramps ..... 19
  - 11.3.2 Single-lane entry ..... 19
  - 11.3.3 Entry with auxiliary lane ..... 19
  - 11.3.4 Two-lane entry ..... 21
  - 11.3.7 Entry to an arterial road ..... 21
- 11.4 Ramp traffic signals ..... 22
- 14 Cyclists ..... 22**
- 14.1 General ..... 22
- 14.2 Treatment at interchanges ..... 23
  - 14.2.3 Alternative routes ..... 23

<b>15 Pavement markings, signs and lighting</b> .....	<b>24</b>
15.1 General .....	24
15.3 Lighting of interchanges.....	24
<b>16 Landscaping and street furniture</b> .....	<b>24</b>
16.1 General .....	24
<b>18 Grade separated intersections and movements</b> .....	<b>24</b>
18.1 Grade separated intersections.....	24
18.2 Grade separated movements .....	29
<b>References</b> .....	<b>31</b>
<b>Appendix C – Examples of ramp signal layouts</b> .....	<b>32</b>
<b>Appendix D – Trapped lane exit – EDD treatment</b> .....	<b>33</b>
<b>Commentary 5</b> .....	<b>34</b>
<b>Commentary 6</b> .....	<b>35</b>
<b>Commentary 7</b> .....	<b>37</b>
<b>Commentary 8</b> .....	<b>40</b>

## Tables

Table 4C-1 – Alternative shoulder widths for ramps with a right hand curve.....	3
Table 4C-2 – Exit ramp options .....	7
Table 4C-3 – Acceleration distance $D_a$ .....	19
Table 4C-4 – Correction of acceleration distances as a result of grade .....	20
Table 4C – C8 1 - Using the VEHSIM acceleration curves to establish ramp lengths for ramps with compound grades.....	41

## Figures

Figure 4C-1 – Alternative treatment for shoulder widths on ramps with a right hand curve .....	4
Figure 4C-2 – Sight distance requirements at exit ramps .....	5
Figure 4C-3 – ‘Detail C’ for examples of single lane exits and ramps for freeways and major divided roads.....	14
Figure 4C-4 - Example of two-lane exit for a freeway or major divided road .....	14
Figure 4C-5 – Major exit type 3a .....	15
Figure 4C-6 – Example of two-lane exit for a freeway or major divided road .....	17
Figure 4C-7 – Example of exit from an arterial road .....	18
Figure 4C-8 – Example of exit from a ramp .....	18
Figure 4C-9 – Entry arrangement NOT to be applied .....	21



Figure 4C-10 - Entry to an arterial road.....	22
Figure 4C-11 – Grade separated cross intersection .....	26
Figure 4C-12 – Grade separated T-junction – Example 1 .....	27
Figure 4C-13 – Grade separated T-junction – Example 2 .....	28
Figure 4C-14 – Grade separated cross intersection examples on the network.....	29
Figure 4C-15 – Grade separated movement examples on the network .....	30
Figure 4C-D1 – Trapped lane exit.....	33
Figure 4C-C6 1 – Average driver deceleration at constant deceleration rate .....	35
Figure 4C-C6 2 – Speed profile of the 85th percentile driver.....	36
Figure 4C-C7 1 – Example speed profile on a deceleration ramp when vehicle stops for a hazard ....	37
Figure 4C-C8 1 – VEHSIM acceleration speed profiles on an on-ramp .....	40
Figure 4C-C8 2 – Example ramp with multiple grades.....	41
Figure 4C-C8 3 – using the VEHSIM acceleration curves to establish ramp lengths for ramps with compound grades.....	42
Figure 4C-C8 4 – Vehicle speed profile .....	42

## **1 Introduction**

### **1.2 Scope of this part**

#### Additions

In undertaking interchange design, practitioners are reminded that the full interchange design process spans the *Austroads Guide to Traffic Management (2020) Part 6: Intersections, Interchanges and Crossings Management* and the *Austroads Guide to Road Design – Part 4C*. For application in Queensland the interchange design process also spans the related Transport and Main Roads *Traffic and Road Use Management Manual (TRUM)* and this *Road Planning and Design Manual (RPDM)*. The design of interchanges in accordance with this RPDM must consider all of the planning and operational issues outlined within the *TRUM* and *Austroads Guide to Traffic Management*.

## **2 Design considerations process and principles**

### **2.2 Design considerations**

#### **2.2.3 Stormwater drainage**

#### Additions

Practitioners should also refer to the Transport and Main Roads *Road Drainage Manual (RDM)* for information on drainage design.

#### **2.2.4 Landscape development**

#### Additions

Practitioners should refer to the Transport and Main Roads *Road Landscape Manual* for information on landscaping around interchanges.

#### **2.4.2 Interchange uniformity and spacing**

#### Additions

System interchanges desirably do not provide any service level access to nearby local or arterial roads and land use. The interchange elements are typically only motorway-motorway connections.

However, some limited level of service function may need to be tolerated at system interchanges where it is not practical to divert traffic from nearby developments or roads to a service interchange located some distance away. This may particularly be the case where as part of an upgrade project, an existing service interchange, providing access to the nearby road network and/or developments, is upgraded to a system interchange.

## **4 Structures**

### **4.9 Safety screens**

#### Additions

Refer to the following Transport and Main Roads documents via <https://www.tmr.qld.gov.au/business-industry/Technical-standards-publications/Report-on-testing-vehicle-windscreens>:

- *Report on Testing to Determine Impact Resistance of Vehicle Windscreens – Overpass Screening Project*

- *Technical Guidelines for the Treatment of Overhead Structures – Objects Thrown or Dropped, and*
- *Policy - Reduction of Risk from Objects Thrown from Overpass Structures onto Roads.*

## **5 Cross-section**

### **5.2 Ramp cross-section**

#### **5.2.1 Number of lanes on ramps**

##### ***Exit Ramps***

##### Additions

If the ramp in question is a direct ramp, semi-direct ramp or outer connector, consideration may be given to not widening the ramp to two lanes, even if it is longer than 600 m in length under the following circumstances:

- truck operating speeds will be similar to general traffic operating speeds on the ramp
- only one lane is required to provide sufficient capacity to meet level of service requirements, and
- the additional lane if provided would be dropped again prior to the downstream entry nose (single lane at the nose).

Omitting the additional lane in such cases avoids having a merge on the ramp which introduces a potential conflict point and may actually have a negative impact on the traffic capacity of the ramp.

#### **5.2.2 Ramp lane widths**

##### Additions

If semi-mountable kerb is used on the outside of loops, the shoulder adjacent to the kerb must be at least 2.0 m wide.

## **6 Design speed**

### **6.4 Ramps**

#### **6.4.1 Ramp design speed**

##### Additions

Refer to Commentary 6 on design speed of deceleration ramps and Commentary 7 for methods of checking the related sight distance.

The design speed on direct ramps, semi-direct ramps and outer connectors, where the exit terminal is designed as an exit to two high speed roadways (refer Section 11.2.3), is to be no less than the design speed of the approach on the through road minus 10 km/h. If this minimum design speed on the ramp cannot be achieved an alternative two lane exit geometry (refer Section 11.2.2) is to be applied.

On all ramps if a speed drop of more than 20 km/h is required, speed reduction measures will be required after leaving the through roadway. Typically warning signage and reduced speed limits together with measures to highlight the alignment of curves provide sufficient speed reduction. On ramps it is preferred that alignment features are not used due to the increased crash potential they may introduce. However, in some cases horizontal alignment features may be suitable.

On exit diagonal ramps, the maximum operating speed on the ramp prior to the intersection should be limited to not more than 60 km/h. This should be achieved through appropriate cross-section and horizontal alignment design combined with signage and pavement markings.

## 7 Sight distance

### 7.2 Stopping sight distance on the major road and minor road

#### Differences

The title of Section 7.2 has been amended to include ramps reflecting that the guidance in this section of *Austroads Guide to Road Design – Part 4C* also applies to ramps.

#### Additions

On curved ramps at interchanges, the alignment design to meet stopping sight distance requirements along the ramp requires sight lines around roadside barriers or other structures calculated as per Section 5.5 of Volume 3, Part 3 of this RPDM. In these cases, the sight distance along the ramp can be difficult to achieve due to sight lines being obstructed by the barriers. This constraint is particularly an issue for right hand curves as the right side shoulder is generally narrower than the left side shoulder in accordance with Table 5.1 of *Austroads Guide to Road Design – Part 4C*.

Where the curve radius is constrained and the required stopping sight distance cannot be achieved with the standard shoulder widths, the lane can be relocated within the total pavement width to the outside of the curve. This is achieved by relocating most of the shoulder width to the inside of the curve as per Table 4C-1 and as shown in Figure 4C-1.

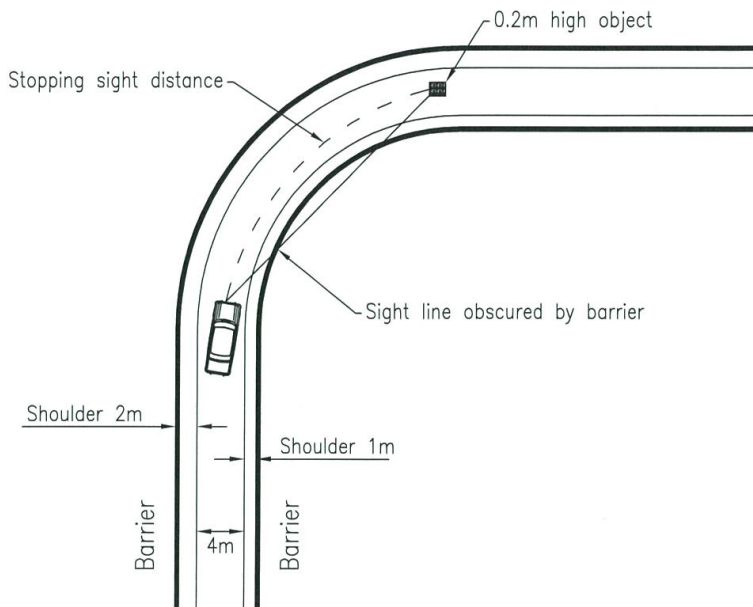
**Table 4C-1 – Alternative shoulder widths for ramps with a right hand curve**

Number of Lanes on the ramp	Lane Width (m)	Shoulder Width (m)			
		Standard treatment <sup>(1)</sup>		Alternative Treatment	
		Left	Right	Left	Right
One	4.0	2.0	1.0	1.0	2.0
Two	3.5	2.0	1.0	1.0	2.0

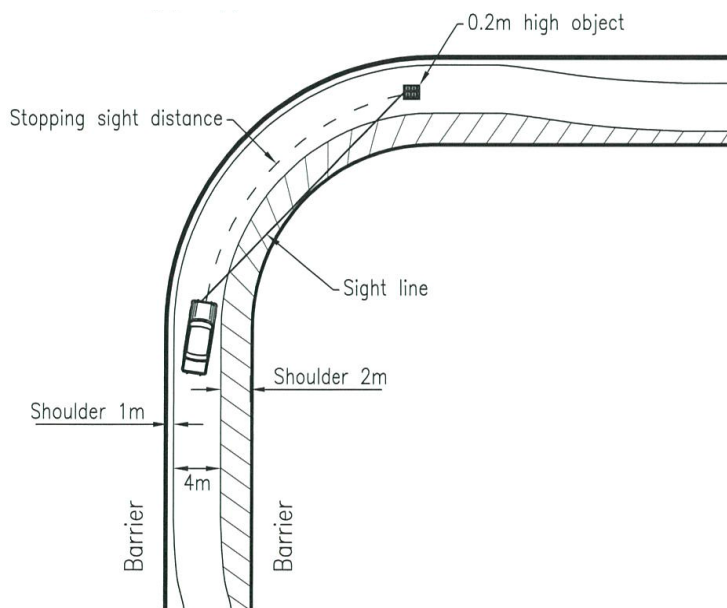
Notes:

1. Standard shoulder width treatment sourced from *Austroads Guide to Road Design – Part 4C*, Table 5.1.

**Figure 4C-1 – Alternative treatment for shoulder widths on ramps with a right hand curve**



(a) Normal shoulder widths



(b) Alternative shoulder widths increasing shoulder on inside of the curve

### 7.3 Exit ramp nose

#### Additions

3rd paragraph of *Austroads Guide to Road Design – Part 4C* is replaced with the following:

In the case of a tapered exit treatment (Figure 4C-2(b)) the sight distance 'X' measured in metres provided should be at least equivalent to 10 seconds of travel time at the operating speed of the major road. For this exit treatment the sight distance should be maintained from the start of the taper continuously to the physical nose, and desirably maintained to a point 60 m beyond the nose. If the required sight distance is not available to the start of the taper or to the physical nose, an auxiliary lane should be provided.

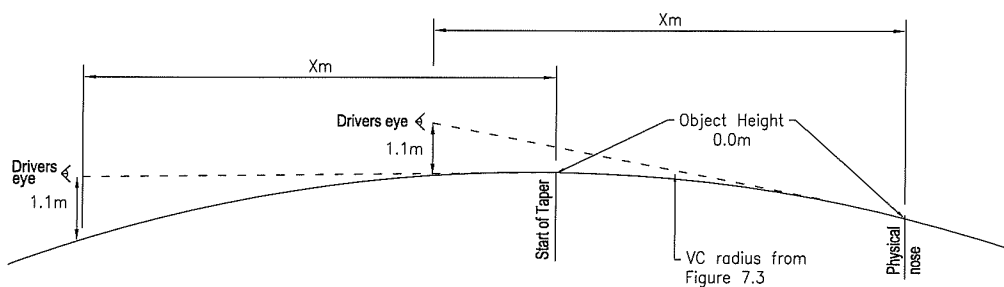
Where an auxiliary lane is provided (Figure 4C-2(c)) the exit is generally more conspicuous and therefore the sight distance 'X' is based on a minimum of seven seconds of travel time at the operating speed of the major road. The sight distance should be maintained continuously throughout the length of the auxiliary lane and exit ramp to the exit nose and desirably to the point 60 m beyond the physical nose.

If the required sight distance is not available to the calculated location for the start of the auxiliary lane, the auxiliary lane should be extended. The additional auxiliary lane length is determined by firstly finding the Point 'C' (refer Figure 4C-2(d)) located seven seconds of travel time prior to the calculated minimum length of the auxiliary lane (as per Section 11.2). The auxiliary lane is then lengthened so that the exit marking at the start of the lane is visible from point 'C' as shown in Figure 4C-2(d).

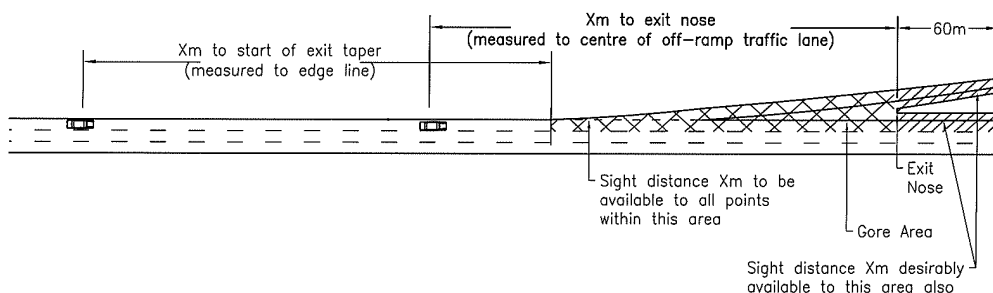
This concession demonstrated in Figure 4C-2(d) is the only sight distance concession permitted in the design of exit ramps.

Figure 7.1 in *Austroads Guide to Road Design – Part 4C* is replaced with Figure 4C-2. Throughout Section 7.3 of *Austroads Guide to Road Design – Part 4C*, all references to Figure 7.1 are to refer instead to Figure 4C-2.

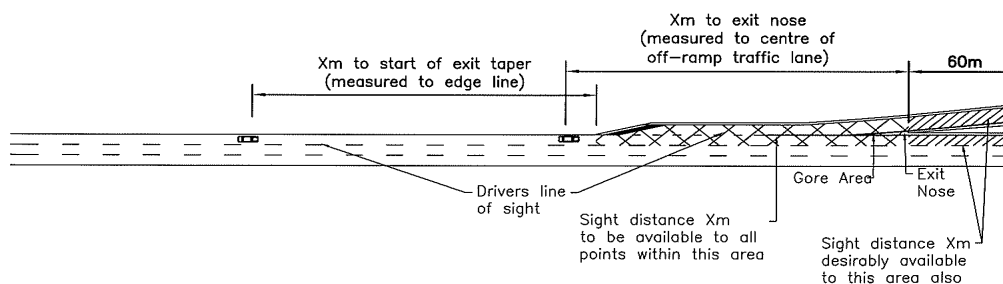
**Figure 4C-2 – Sight distance requirements at exit ramps**



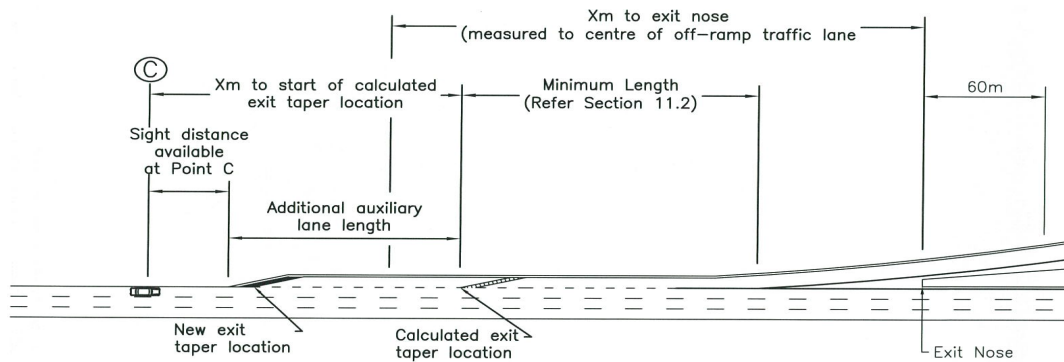
(a) Elevation – exit taper



(b) Plan – exit taper



(c) Plan – auxiliary lane



(d) Plan – auxiliary lane extension where sight distance is constrained

Notes:

In Figures 4C-2(a) and (b), the distance X m is based on a minimum of 10 seconds of travel time.

In Figures 4C-2(c) and (d), the distance X m is based on a minimum of 7 seconds of travel time.

In Figure 4C-2(d), sight distance available to the physical nose and beyond are measured in accordance with Figure 4C-2(c).

## 8 Horizontal alignment

### 8.2 Minor road

#### 8.2.1 Curvature

##### Additions

The following text is added to the end of this section:

- Safe Intersection Sight Distance (SISD) may be restricted by the bridge parapets and safety barrier at closed diamonds. Where sight distance at the intersection is restricted at either or both of the ramp terminals:
  - The parapets and safety barrier, including any screens or rails, may have to be set back (including appropriate bridge widening) to achieve the required sight distance.
  - Even if visibility over the tops of barriers provides sufficient sight distance, consideration should be made to future additions to the barriers such as rails or throw screens. In these cases, it is preferred to set back the barrier to achieve the required sight distance.
  - The intersections may need to be relocated further from the bridge.

## 10 Ramp terminals at major roads

##### Differences

Replace title of Section 10 in *Austroads Guide to Road Design – Part 4C* with:

Ramp terminals at the minor road

## 11 Ramp terminals at the major road

### 11.1 General

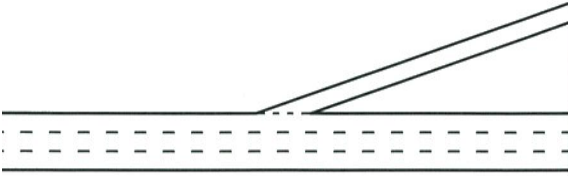
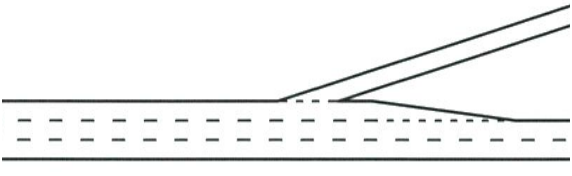
##### Additions

At exits, the ramp crossfall / superelevation should continue as an extension of the major road crossfall / superelevation up to the physical nose between the two sections of pavement. Similarly, at

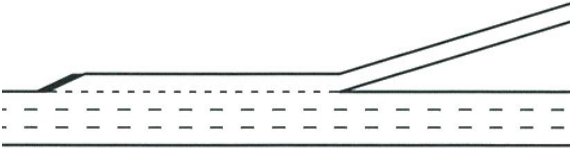
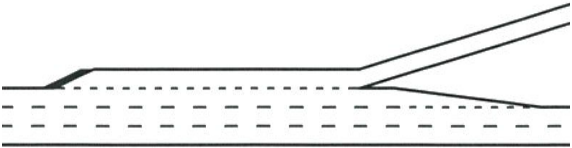
entrances, the ramp crossfall / superelevation should continue as an extension of the major road crossfall / superelevation from the physical nose onwards.

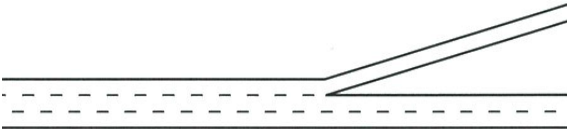
Table 4C-2 provides a summary of the various exit ramps options and a discussion on the merits or applicability of each.

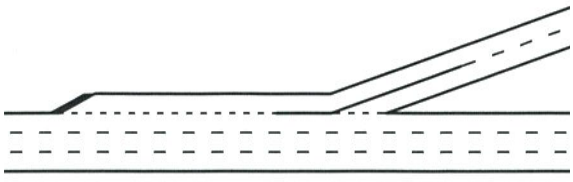
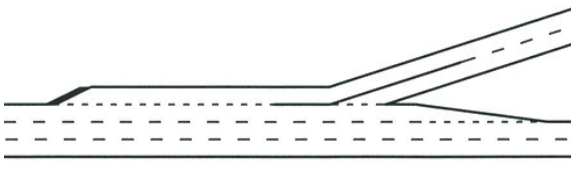
**Table 4C-2 – Exit ramp options**

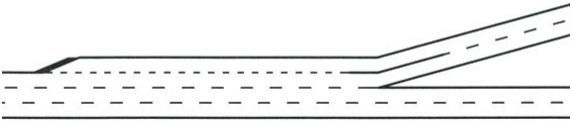
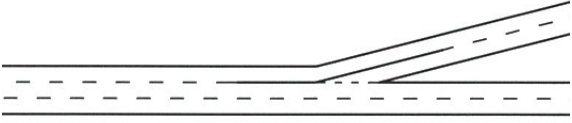
<b>Type 1 – Single lane exit</b>	
<p><b>1a(i) Single lane exit – minimum treatment</b></p>  <p>Service interchange only – major / minor roads</p> <p>Typically only used at low exit volume ramps with good sight distance. This layout is the minimum permissible in low volume constrained situations and most typically to retrofit an additional exit on an existing motorway subject to constraints.</p>	<p>Refer to Section 11.2.1 for applicable design guidance.</p> <p>Ramp traffic volume – low:</p> <ul style="list-style-type: none"> <li>• Total ramp volume typically &lt; 10% of the approaching traffic in the two left nearside lanes of the motorway, and</li> <li>• Peak period ramp volume typically &lt; 50% of ramp capacity ≈ LOS B (refer <i>Austroads Guide to Traffic Management, Part 3: Transport Study and Analysis Methods (2020)</i>).</li> </ul> <p>Basic no. of lanes – complies.</p> <p>Lane balance – complies.</p>
<p><b>1a(ii) Single lane exit – minimum treatment with lane drop after the exit</b></p>  <p>Service interchange only – major / minor roads</p> <p>Typically only used at low exit volume interchanges with good sight distance. This layout is the minimum permissible in low volume constrained situations and most typically is used to retrofit an additional exit on an existing motorway subject to constraints.</p> <p>This layout is rarely used in practice except where there are physical constraints, such as existing structures downstream of the exit.</p>	<p>Refer to Section 11.2.1 and 11.2.4 for applicable design guidance.</p> <p>Ramp traffic volume – low:</p> <ul style="list-style-type: none"> <li>• Total ramp volume typically &lt; 10% of the approaching traffic in the two left nearside lanes of the motorway, and</li> <li>• Peak period ramp volume typically &lt; 50% of ramp capacity ≈ LOS B (refer <i>Austroads Guide to Traffic Management, Part 3: Transport Study and Analysis Methods (2020)</i>).</li> </ul> <p>Basic no. of lanes – complies.</p> <p>Lane balance – complies.</p>

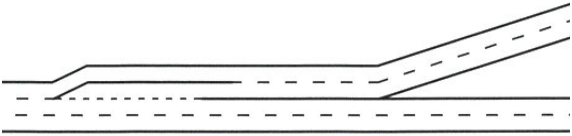
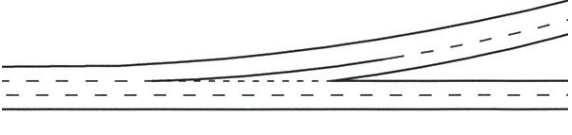



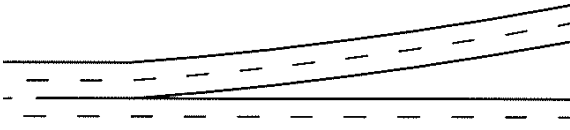
<b>Type 1 – Single lane exit</b>	
<p><b>1b(i) Single lane exit – auxiliary lane</b></p>  <p>Service interchange – major / minor roads System interchange Preferred single lane exit ramp configuration</p>	<p>Refer to Section 11.2.1 for applicable design guidance.</p> <p>Ramp traffic volume – low to medium:</p> <ul style="list-style-type: none"> <li>• Total ramp volume typically &lt; 20% of the approaching traffic in the two left nearside lanes of the motorway, and</li> <li>• Peak period ramp volume typically &lt; 75% of ramp capacity ≈ LOS C (refer <i>Austroads Guide to Traffic Management, Part 3: Transport Study and Analysis Methods (2020)</i>).</li> </ul> <p>Basic no. of lanes – complies. Lane balance – complies.</p>
<p><b>1b(ii) Single lane exit – auxiliary lane with lane drop after the exit</b></p>  <p>Service interchange – major / minor roads System interchange</p> <p>This layout may be applied where the motorway volume downstream does not require the equal number of lanes as the approach. However it is preferably only applied where there are existing physical constraints, such as structures, downstream of the exit prevent the use of layout 1b(i).</p>	<p>Refer to Section 11.2.1 and 11.2.4 for applicable design guidance.</p> <p>Ramp traffic volume – low to medium</p> <ul style="list-style-type: none"> <li>• Total ramp volume typically &lt; 20% of the approaching traffic in the two left nearside lanes of the motorway, and</li> <li>• Peak period ramp volume typically &lt; 75% of ramp capacity ≈ LOS C (refer <i>Austroads Guide to Traffic Management, Part 3: Transport Study and Analysis Methods (2020)</i>).</li> </ul> <p>Basic no. of lanes – complies. Lane balance – complies.</p>

<b>Type 1 – Single lane exit</b>	
<p><b>1c Single lane exit – trapped lane</b></p>  <p>Service interchange only – major / minor roads</p> <p>This layout is not preferred and may only be used for application at constrained sites. Motorway downstream volumes do not require the equal number of lanes as the approach.</p> <p>It is most typically located on motorways in inner urban areas or urban arterial roads where the structural design of bridges constrain the number of lanes downstream.</p> <p>May be applied at sites where an auxiliary lane from a previous interchange is the trapped lane. The previous entry ramp should be close enough that the left lane operates as a weaving lane only and through traffic on the major road typically does not enter the lane.</p>	<p>Refer to Section 11.2.1 and Appendix D for applicable design guidance.</p> <p>Ramp traffic volume – low to medium:</p> <ul style="list-style-type: none"> <li>• Total ramp volume typically &lt; 20% of the approaching traffic in the two left kerb lanes of the motorway, and</li> <li>• Peak period ramp volume typically &lt; 75% of ramp capacity ≈ LOS C (refer <i>Austroads Guide to Traffic Management, Part 3: Transport Study and Analysis Methods (2020)</i>).</li> </ul> <p>Basic no. of lanes – does not comply.</p> <p>Lane balance – does not comply.</p>

<b>Type 2 – Two lane exit</b>	
<p><b>2a(i) Two lane exit</b></p>  <p>Service interchange – major / minor roads System interchange Preferred two lane exit ramp configuration</p>	<p>Refer to Section 11.2.2 for applicable design guidance.</p> <p>Ramp traffic volume – medium:</p> <ul style="list-style-type: none"> <li>• Peak period ramp volume greater than 100% of ramp capacity for a single lane.</li> <li>• The purpose of this arrangement is to provide a ramp capacity close to that of a single lane. Capacity traffic flow for a single lane ramp cannot typically be achieved with a single lane exit.</li> </ul> <p>Basic no. of lanes – complies. Lane balance – complies.</p>
<p><b>2a(ii) Two lane exit – lane drop after exit</b></p>  <p>Service interchange – major / minor roads System interchange</p> <p>This layout may be applied where the motorway volume downstream does not require the equal number of lanes as the approach. However it is preferably only applied where existing physical constraints, such as structures, downstream of the exit prevent the use of layout 2a(i).</p>	<p>Refer to Sections 11.2.2 and 11.2.4 for applicable design guidance.</p> <p>Ramp traffic volume – medium:</p> <ul style="list-style-type: none"> <li>• Peak period ramp volume greater than 100% of ramp capacity for a single lane.</li> <li>• The purpose of this arrangement is to provide a ramp capacity close to that of a single lane. Capacity traffic flow for a single lane ramp cannot typically be achieved with a single lane exit.</li> </ul> <p>Basic no. of lanes – complies. Lane balance – complies.</p>

<b>Type 2 – Two lane exit</b>	
<p><b>2b Two lane exit – trapped lane</b></p>  <p>Service interchange – major / minor roads System interchange</p> <p>This layout is not preferred and may only be used for application at constrained sites and where motorway downstream volumes do not require the equal number of lanes as the approach.</p> <p>It is most typically located on motorways in inner urban areas or urban arterial roads where the structural design of bridges constrain the number of lanes downstream.</p> <p>May be applied at sites where an auxiliary lane from a previous interchange is the trapped lane. The previous entry ramp should be located close enough that the left lane operates as a weaving lane only, and through traffic on the major road typically does not enter the lane.</p>	<p>Refer to Section 11.2.2 and Appendix D for applicable design guidance.</p> <p>Ramp traffic volume – medium:</p> <ul style="list-style-type: none"> <li>• Peak period ramp volume greater than 100% of ramp capacity for a single lane.</li> <li>• The purpose of this arrangement is to provide a ramp capacity close to, or just above that of a single lane. Capacity traffic flow for a single lane ramp cannot typically be achieved with a single lane exit.</li> </ul> <p>Basic no. of lanes – does not comply.</p> <p>Lane balance – complies.</p>
<p><b>2c Two lane exit – trapped lane</b></p>  <p>Service interchange – major / minor roads System interchange</p> <p>This layout is not preferred and may only be used for application at constrained sites. It may be applied at sites where an auxiliary lane from a previous interchange is the trapped lane. The previous entry ramp should be located close enough that the left lane operates as a weaving lane only, and through traffic on the major road typically does not enter the lane.</p>	<p>Refer to Section 11.2.2 for applicable design guidance.</p> <p>Ramp traffic volume – medium:</p> <ul style="list-style-type: none"> <li>• Peak period ramp volume greater than 100% of ramp capacity for a single lane.</li> <li>• The purpose of this arrangement is to provide a ramp capacity close to, or just above that of a single lane. Capacity traffic flow for a single lane ramp cannot typically be achieved with a single lane exit.</li> </ul> <p>Basic no. of lanes – does not comply.</p> <p>Lane balance – complies if left lane is added at previous interchange. Otherwise it does not comply.</p>

<b>Type 3 – Major exits</b>	
<p><b>3a Major exit to a minor roads – ramp geometry</b></p>  <p>Service interchange – major / minor roads System interchange.</p> <p>At system interchanges this ramp arrangement is to be used where the ramp geometry does <b>NOT</b> allow for ramp operating speeds to be maintained within 10 km/h of the approach motorway operating speed.</p>	<p>Refer to Section 11.2.2 for applicable design guidance.</p> <p>Exiting traffic volume – high:</p> <ul style="list-style-type: none"> <li>Ramp exit carries &gt; 30% of the total approaching traffic.</li> </ul> <p>Basic no. of lanes – non compliant: trapped left lane.</p> <p>Lane balance – complies.</p>
<p><b>3b Exit to two major roads – major fork geometry</b></p>  <p>System interchange only</p> <p>This ramp arrangement is to be used where the ramp geometry allows for operating speeds on the ramp to be maintained within 10 km/h of the approach motorway operating speed for the full length of the ramp.</p>	<p>Refer to Section 11.2.3 for applicable design guidance.</p> <p>Diverging traffic volume – high:</p> <ul style="list-style-type: none"> <li>Both diverging roads carry &gt; 30% of the approaching traffic.</li> </ul> <p>Basic no. of lanes – non compliant: trapped left lane.</p> <p>Lane balance – complies.</p>

<b>Type 4 – Motorway splits</b>	
<p><b>4a Exit to two major roads – 4 lane approach with two lanes exit to each direction – ramp geometry</b></p>  <p>System interchange.</p> <p>This arrangement is used where the ramp geometry does <b>NOT</b> allow for ramp operating speeds to be maintained within 10 km/h of the approach motorway operating speed.</p> <p>This arrangement is only used in circumstances where the approach motorway volume requires four lanes. Extensive mitigation is required due to the presence of two trapped exit lanes. This will typically include overhead gantry signage.</p>	<p>Refer to Section 11.2.2 for applicable design guidance.</p> <p>Exiting traffic volume – high: ramp exit carries &gt; 30% of the total approaching traffic.</p> <p>Basic no. of lanes – non compliant: trapped left lanes.</p> <p>Lane balance – non – compliant.</p>
<p><b>4b Exit to two major roads – 4 lane approach with two lanes exit to each direction – major fork geometry</b></p>  <p>System interchange</p> <p>This arrangement is used where the ramp geometry allows for ramp operating speeds to be maintained within 10 km/h of the approach motorway operating speed.</p> <p>This arrangement is only used in circumstances where the approach motorway volume requires four lanes. Extensive mitigation is required due to the presence of two trapped exit lanes. This will typically include overhead gantry signage.</p>	<p>Refer to Section 11.2.3 for applicable design guidance.</p> <p>Diverging traffic volume – high: both diverging roads carry &gt; 30% of the approaching traffic.</p> <p>Basic no. of lanes – non compliant: trapped left lanes.</p> <p>Lane balance – non – compliant.</p>

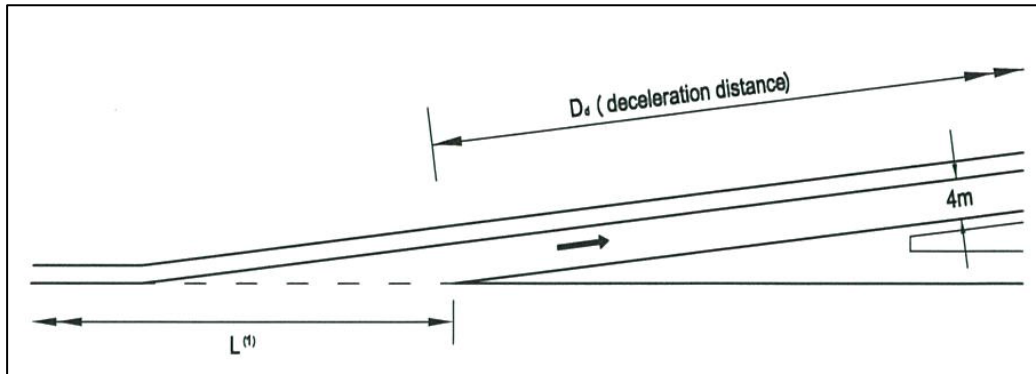
## 11.2 Exit ramps

### 11.2.1 Single-lane exits

#### Differences

Figure 11.1(d) in *Austroads Guide to Road Design – Part 4C* is replaced with Figure 4C-3.

#### **Figure 4C-3 – ‘Detail C’ for examples of single lane exits and ramps for freeways and major divided roads**



In Figure 11.1(a) and Figure 11.1(b) in *Austroads Guide to Road Design – Part 4C*, references to “detail C” are to be taken as reference to Figure 4C-3.

Table 11.1 in *Austroads Guide to Road Design – Part 4C*, Note 1 is replaced with the following:

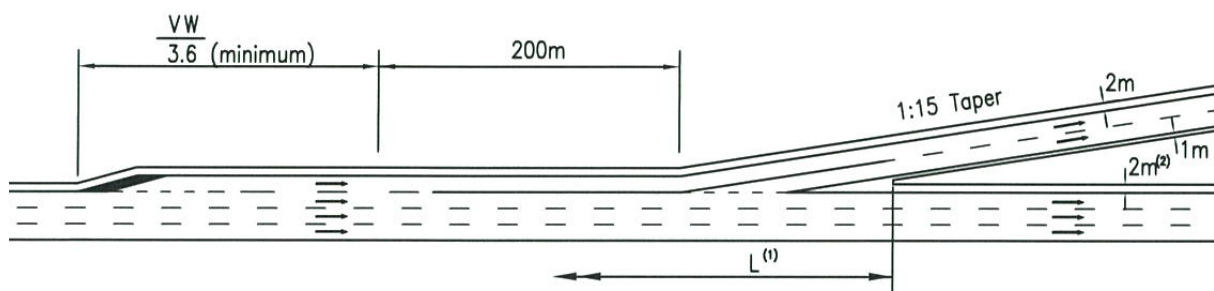
1. The design speed of the through road is as defined in Volume 3, Part 3 of the RPDM.

### 11.2.2 Two-lane exits

#### Differences

Figure 11.3 in *Austroads Guide to Road Design – Part 4C* is replaced with Figure 4C-4. All references in *Austroads Guide to Road Design – Part 4C* to Figure 11.3 are to refer instead to Figure 4C-4.

#### **Figure 4C-4 - Example of two-lane exit for a freeway or major divided road**



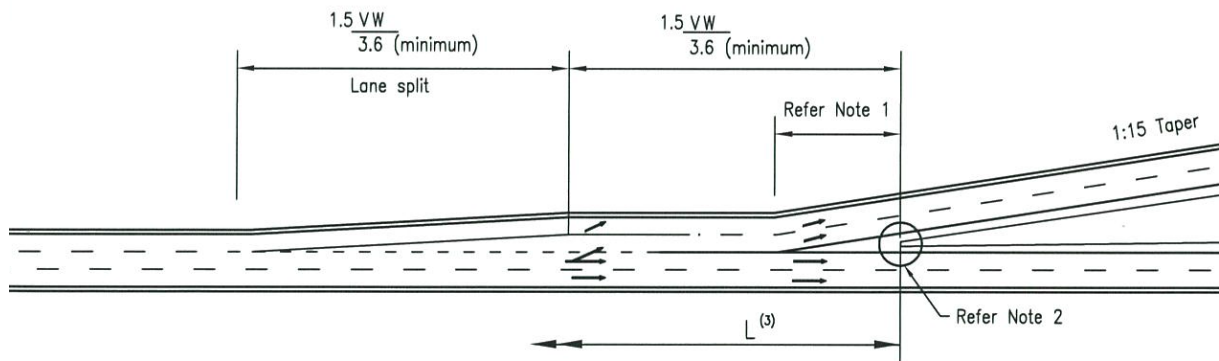
#### Additions

Type 3a two lane exit ramps (refer to Table 4C-2) are required when a very high volume of traffic is exiting the motorway at a ramp. The key difference with other two lane exit ramp types is the second approach lane from the left splits to either the exit at the ramp or continue along the motorway. The leftmost approach lane is an exclusive exit lane. This allows traffic in either of the two left lanes to exit without needing to change lanes.

Figure 4C-5 shows a major exit from the motorway with a trapped left lane and the split occurring in the second leftmost lane. The dimensions shown represent the minimum dimensions for this exit ramp

type. The length of the auxiliary lane can be extended, if desired, by introducing a parallel lane section between the end of the lane split and the start of the painted nose.

**Figure 4C-5 – Major exit type 3a**



- Notes:
- 1) Distance between nose of painted island and physical nose is approximately 63 m for the dimensions shown in Figure 11.1 of *Austroads Guide to Road Design – Part 4C*.
  - 2) Refer to detail B in Figure 11.1 of *Austroads Guide to Road Design – Part 4C*.
  - 3)  $L$  = distance between the exit ramp and preceding entry ramp. Refer to *Austroads Guide to Traffic Management Part 6: Intersections, Interchanges and Crossings Management (2020)*.

### 11.2.3 Exits to two high-speed roadways

#### Differences

All text in this section is replaced with the following. Figure 11.4 in *Austroads Guide to Road Design – Part 4C* is replaced with Figure 4C-6.

A different type of operation applies where traffic diverges to two high-speed roads that are of similar importance. In this case, either both roadways diverge tangentially from each other or one roadway diverges as a high speed curve. This is referred to as a 'major fork' and differs to the arrangement where one roadway diverges at an angle as with a normal ramp. The intent of the geometric design of the exit is to convey the message to drivers that they are exiting to another major road.

A key design element for a major fork is that the central lane (or one of the central lanes in the case of approaching roads with four or more lanes) must allow the traffic in that lane to choose either of the two diverging roads. At least two lanes continue to each of the diverging roadways.

Major forks as described in this section are only to be used when all of the following criteria are satisfied:

- the interchange is a motorway – motorway system interchange with both roads of equal importance
- both motorways have design speeds of 100 km/h or greater
- the split of traffic to each direction must be at least 30/70 (i.e. near equal with at least 30% of traffic on each exit), and
- the ramp design speed for both exits must be within 10 km/h of the operating speed of the approach road.

Figure 4C-6 illustrates the principle of diverging two major roadways, where the layout and alignment is based on achieving a high standard of alignment for both high speed movements.



Figures 4C-6(a) and 4C-6(b) show the practice most typically applied in Queensland where one of the diverging roads continues on a near straight alignment as a continuation of the approach road, and the alignment of the other diverging road is curved. The point of the gore is placed:

- in the case of the left diverging road being curved, Figure 4C-6(a), in direct alignment with left lane line of the lane to be split
- in the case of the right diverging road being curved, Figure 4C-6(b), in direct alignment with right lane line of the lane to be split.

The key design elements of these arrangements are as follows:

- the lane split length is to be achieved over the length calculated in the following equation:

$$Length = \frac{1.5 \times V \times W}{3.6}$$

where

V = design speed of the major road approach (km/h)

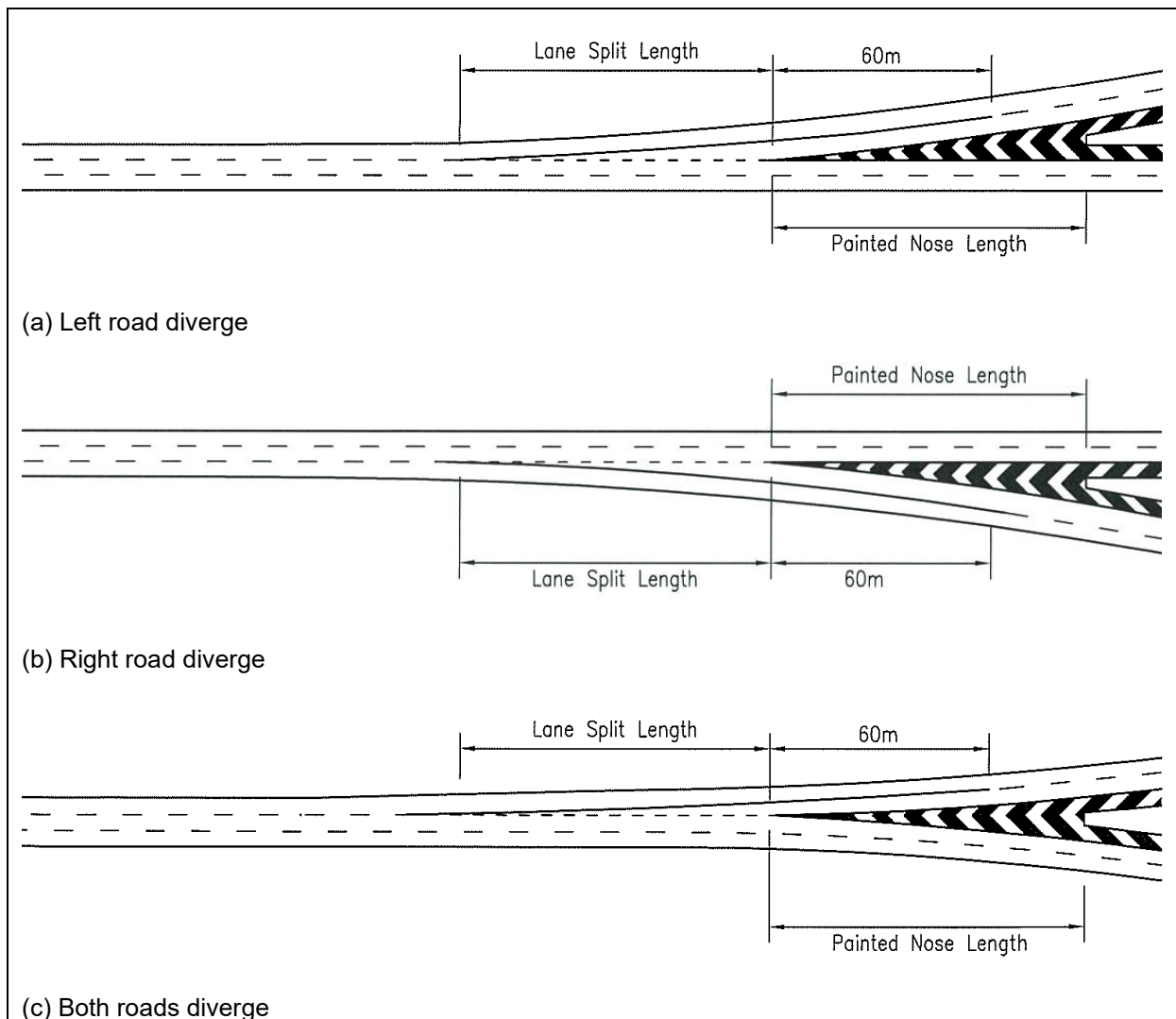
W = lane width (typically 3.5 m).

This equation results in a length of approximately 160 m for design speed of 110 km/h (posted speed of 100 km/h).

- The length of the painted gore to the nose between the two diverging roads is to be at least the same as the lane split length to allow for driver error. Shorter lengths do not make sufficient allowance for driver error while longer lengths may encourage additional unsafe carriageway lane changes.
- The lane line between the diverging outside lane and the lane being split shall be a continuous lane line for the full length of the lane split and should extend 60 m past the physical nose where lane changing movements are undesirable.

Figure 4C-6(c) shows an arrangement where both roads diverge tangentially. In this situation, the nose should be placed in direct alignment with the centre of the central lane to be split. A continuity line is to be marked extending from the nose on an alignment parallel to the lane line for the diverging road with the higher traffic volume. The pavement marking arrangement shown in *Austroads Guide to Road Design – Part 4C* is not to be applied as it results in an excessive area on the approach to the nose that does not provide sufficient driver guidance.

**Figure 4C-6 – Example of two-lane exit for a freeway or major divided road**



In all cases, sight distance to the physical nose is to be at least 440 m measured from an eye height of 1.1 m to zero object height.

The operating conditions at locations of major forks are different from those at other interchanges and some stringent controls are required to ensure their safe operation. *Austroads Guide to Traffic Management Part 6: Intersections, Interchanges and Crossings Management (2020)* identifies a number of aspects important to the traffic operation of major forks.

#### 11.2.4 Lane drop at an exit

##### Additions

The lane drop must be located on a uniform grade or in a sag and preferably on straight alignment so that drivers can see the full length of the taper.

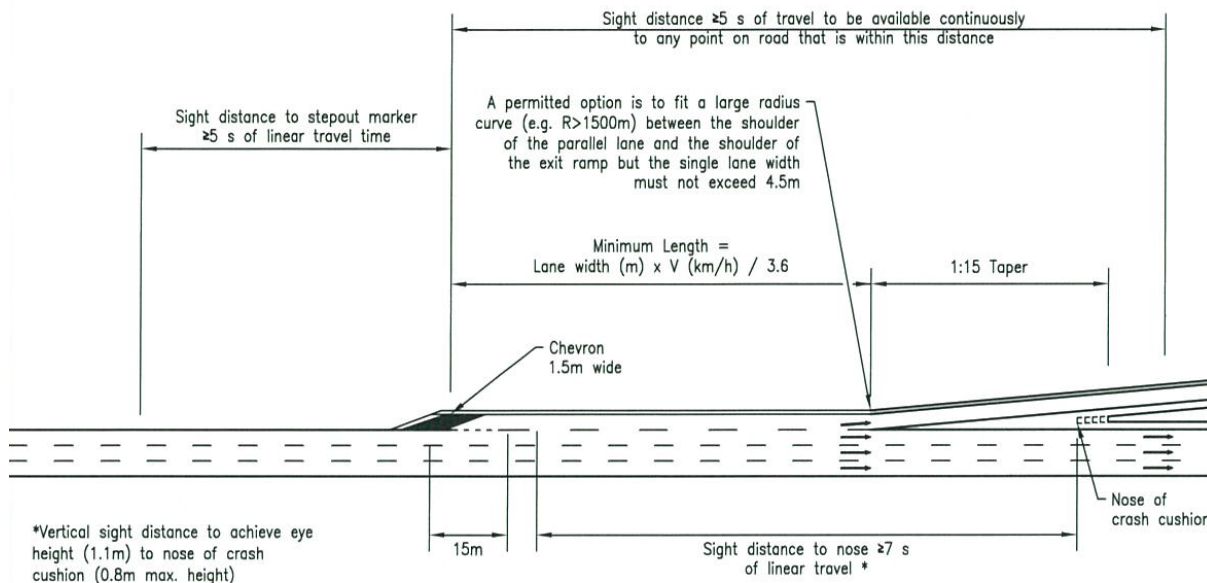
### 11.2.5 Exit from an arterial road

There is no equivalent Section 11.2.5 in *Austroads Guide to Road Design – Part 4C*.

New

Ramp exits from an arterial road can be used in place of at-grade intersections to provide a higher level of service and to maintain higher operating speeds on the arterial road. Figure 4C-7 shows a typical single lane exit for a ramp exit from an arterial road.

**Figure 4C-7 – Example of exit from an arterial road**



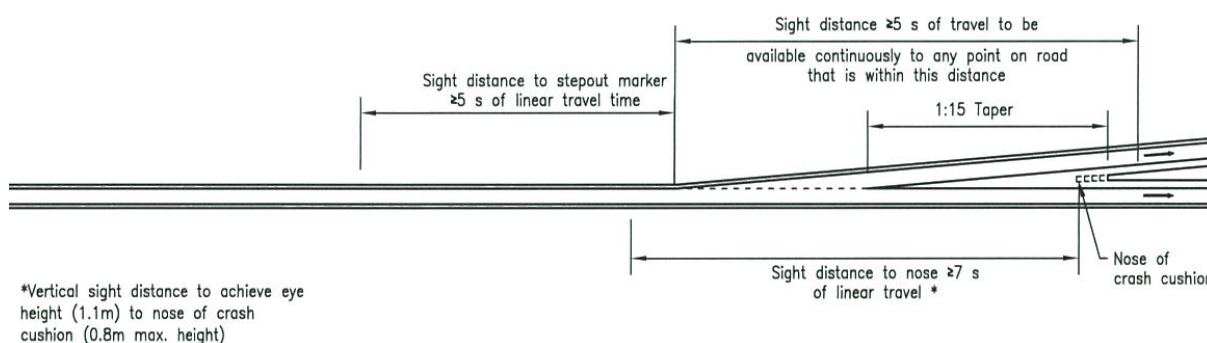
### 11.2.6 Exit from another ramp

There is no equivalent Section 11.2.6 in *Austroads Guide to Road Design – Part 4C*.

New

At some interchanges it may be necessary for a single ramp exit to carry traffic to be split onto multiple ramps. In these cases, it will be necessary for a ramp exit on the ramp to be provided. Due to the generally lower operating speed on the ramp and higher level of driver awareness, the design requirements for the ramp exit from the ramp are not to the same level as a ramp exit from a motorway. Figure 4C-8 shows a typical ramp exit from another ramp.

**Figure 4C-8 – Example of exit from a ramp**



### 11.3 Entry ramps

#### 11.3.2 Single-lane entry

##### Additions

The zip merge without the continuity line is not used for entry ramps to motorways in Queensland.

#### 11.3.3 Entry with auxiliary lane

##### Differences

Delete the following part of the last sentence in the first paragraph in *Austroads Guide to Road Design – Part 4C*:

*“in AGRD Part 4A (Austroads 2010a) should be used to assess the length of ramp required for acceleration to the design speed of the through road.”*

Delete the reference to Table 11.2 in *Austroads Guide to Road Design – Part 4C* in the second paragraph and replace it with Table 4C-3 and 4C-4.

Replace 'Table 11.2: Acceleration Distance  $D_a$ ' and 'Table 11.3: Correction of acceleration distances as a result of grade' in *Austroads Guide to Road Design – Part 4C* with Tables 4C-3 and 4C-4 respectively.

##### Additions

The design speed of the through road for the purpose of calculating the acceleration distance for the entry ramp is usually made equal to the mean free speed of the through road (which is often approximately equal to the speed limit).

Where very long entry lanes (> 1000 m) are required from the processes in this section, the entry lane is to be treated as an added lane which may become a climbing lane for slow moving vehicles. The end of the lane is to be treated as a lane drop at the appropriate location.

In Table 11.4 of *Austroads Guide to Road Design – Part 4C* replace 'Length based on 4 sec of travel time', in the 'Desirable' column and 'High-speed freeways (operating speed > 80 km/h)' row, with 'Length based on 7 sec of travel time'.

**Table 4C-3 – Acceleration distance  $D_a$**

Design speed of through road (km/h)	Acceleration Distance $D_a$ (m) – for flat grade							
	Where design speed of curve A (km/h)							
	0	20	30	40	50	60	70	80
70	140	135	125	105	75	45	-	-
80	215	205	195	175	150	115	75	-
90	300	295	280	265	235	200	160	90
100	405	395	385	365	340	305	265	195
110	600	590	580	560	535	500	460	385
120	860	850	840	820	795	760	720	645

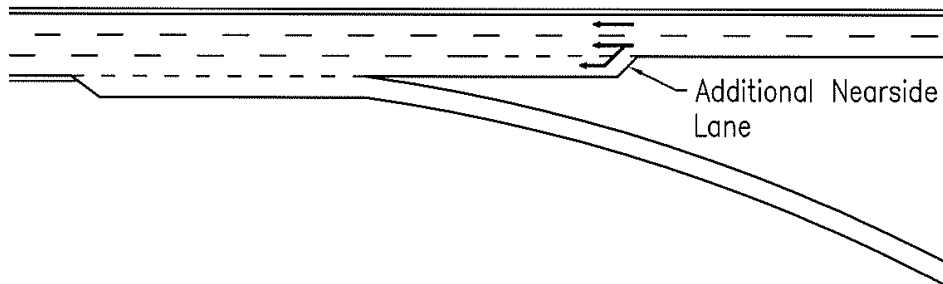
Notes:

1. This table applies to situations where a curve having a design speed less than the design speed of the through road is provided prior to the ramp nose (refer to Section 11.3.3).
2. Where ramp traffic signals (refer to Section 11.4) are provided near the nose, the acceleration distance required (from a stopped condition) should be based on a design speed of Curve A of 0 km/h.



It is not uncommon for the entry ramp to form an added lane at the entry merge. The arrangement where an additional nearside lane is created on the motorway mainline immediately prior to the entry ramp, as depicted in Figure 4C-9, is not to be adopted.

**Figure 4C-9 – Entry arrangement NOT to be applied**



### 11.3.4 Two-lane entry

#### Differences

Delete the reference to Table 11.2 in *Austroads Guide to Road Design – Part 4C* in the first paragraph and replace it with Table 4C-3 and 4C-4.

Delete the last sentence in the first paragraph in *Austroads Guide to Road Design – Part 4C*:

*“AGRD Part 4A (Austroads 2010a) should be used to assess the length of ramp required for acceleration to the design speed of the road”.*

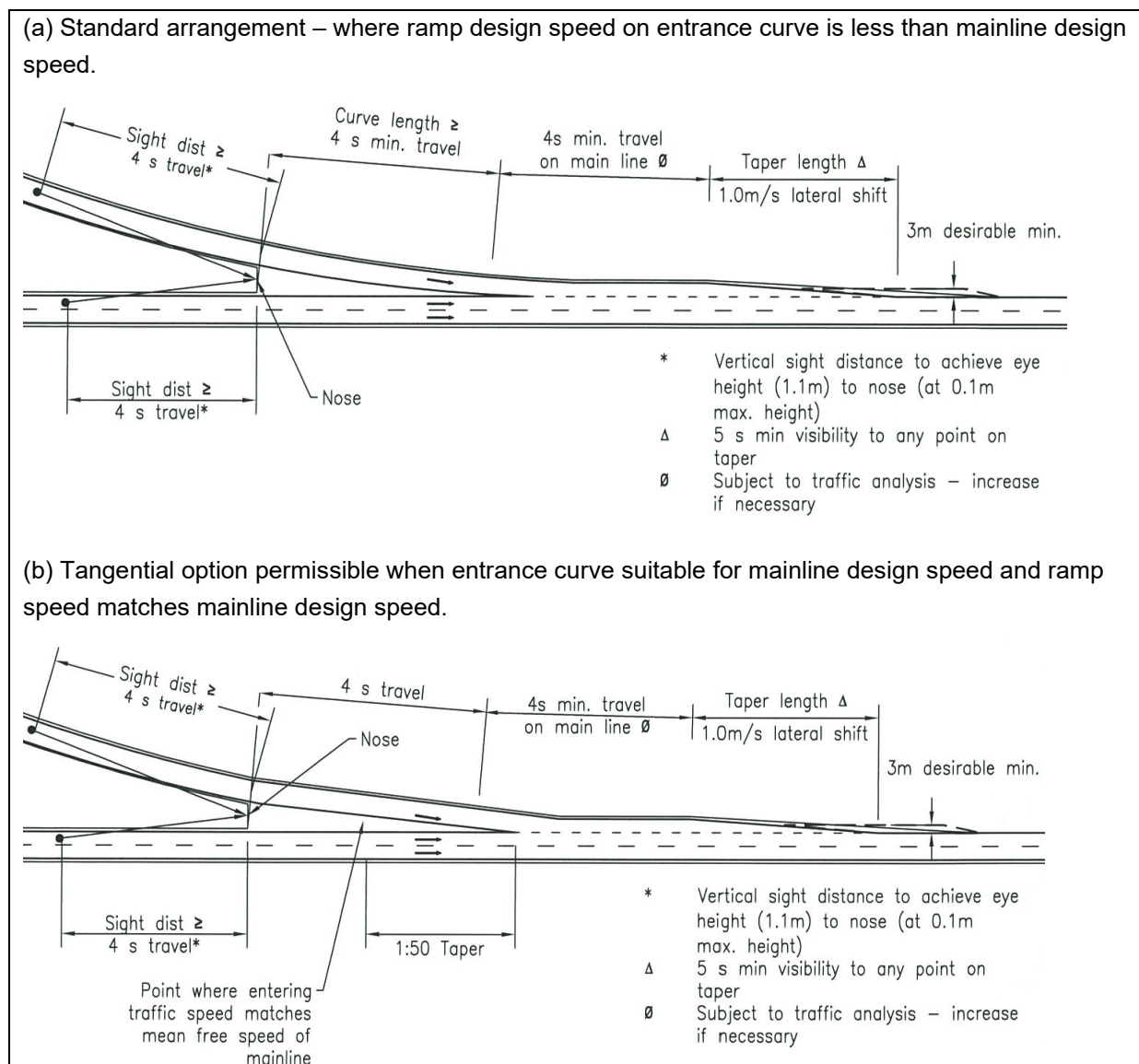
### 11.3.7 Entry to an arterial road

There is no equivalent Section 11.3.7 in *Austroads Guide to Road Design – Part 4C*.

#### New

Ramp entries to an arterial road can be used in place of at-grade intersections to provide a higher level of service and to maintain higher operating speeds on the arterial road. Figure 4C-10 shows options for a typical ramp entry to an arterial road.

**Figure 4C-10 - Entry to an arterial road**



## 11.4 Ramp traffic signals

### Differences

The guidance in Section 11.4 of *Austrroads Guide to Road Design – Part 4C* is to be considered informative only. Guidance for application in Queensland is provided in the *Transport and Main Roads Design guidelines for the provision of managed motorway ramp signalling*. This can be found in Section 8.4 of *TRUM Volume 1 – Guide to Traffic Management, Part 9 Traffic Operations*, via:

<https://www.tmr.qld.gov.au/business-industry/Technical-standards-publications/Traffic-and-Road-Use-Management-manual/Volume-1>

## 14 Cyclists

### 14.1 General

#### Additions

The policy position with respect to cyclists using freeways in Queensland is given in the *Transport and Main Roads Cycling Infrastructure Policy*.

In general, cycling will only be permitted on the shoulders of rural motorways and will not be permitted on the shoulders of new urban motorways. Any new motorway projects and upgrades should aim to achieve a high level of safety and service for cyclists.

In determining the suitability of the motorway for on-road cycling, detailed consideration should be given to the following factors at the interchanges:

- volume of motor vehicles using the ramps
- sight distances to cyclists crossing the ramps, and
- existence of multi-lane ramps.

The suitability of the motorway as an on-road cycle facility and general cross section details for accommodation of cyclists on motorway shoulders are considered in Volume 3, Part 3 of the RPDM.

## **14.2 Treatment at interchanges**

### Additions

The principles to be applied in allowing cyclists to cross the motorway ramps as shown in Figure 14.1(a) in *Austroads Guide to Road Design – Part 4C* include:

- cyclists must have sufficient advance awareness that they must cross high speed motor vehicle traffic, and
- motorists exiting or entering the motorway are expecting to merge / diverge smoothly without being interrupted by bicycle crossing facilities.

The facility for cyclists to cross the ramp must clearly communicate that all cyclists must give way to approaching traffic on the ramp and can do so safely.

In addition to the guidance in *Austroads Guide to Road Design – Part 4C* with regards to cyclist delays, if motor vehicle volumes do not exceed 800 vehicles per hour at any time during the day, the cyclist path through the interchange as shown in Figure 14.1(a) in *Austroads Guide to Road Design – Part 4C* is encouraged (refer Commentary 5).

Where cyclists are permitted to ride on the motorway shoulder on a marked cycle route, additional signage is necessary if the cycle route is marked. The signs at the interchange are required in accordance with the *Manual of Uniform Traffic Control Devices (MUTCD)*:

- at entry and exit ramps, warning motorists that they might encounter cyclists crossing ramps
- at all interchanges to guide cyclists safely across the ramps or via an alternative route, and
- to advise cyclists of a requirement to leave the motorway (e.g. at 'squeeze points' such as narrow shoulder on bridges) or to cross a ramp.

### **14.2.3 Alternative routes**

#### Additions

The alternative route should aim to provide cyclists with a facility of a similar standard to that of the motorway, and with minimum deviation or added distance.



## **15 Pavement markings, signs and lighting**

### **15.1 General**

#### Additions

MUTCD is the primary reference with regards to pavement markings and signs in Queensland.

### **15.3 Lighting of interchanges**

#### Additions

Practitioners should refer to the Volume 6 – Lighting of this RPDM for information on lighting around interchanges.

## **16 Landscaping and street furniture**

### **16.1 General**

#### Additions

Practitioners should refer to the Transport and Main Roads *Road Landscape Manual* for information on landscaping around interchanges.

## **18 Grade separated intersections and movements**

There is no equivalent Section 18 in *Austroads Guide to Road Design – Part 4C*.

#### New

### **18.1 Grade separated intersections**

On roads other than motorways, grade separated intersections may be considered as an alternative to a full interchange. These intersection types are used more extensively in the UK and are referred to as “Compact grade separated junctions”. Grade separated intersections in Queensland are characterised by:

- Left in, left out treatments on the major road:
  - Left in treatment – Deceleration Lanes
    - The warrant for a left turn deceleration lane AUL(s), AUL or CHL is determined in accordance with the warrants for turn treatments contained in Volume 3, Part 4A of this RPDM. It is expected in these cases that the minimum treatment will be an AUL(s).
    - Where an AUL/CHL treatment is provided the length of the deceleration lane is to be designed in accordance with Volume 3, Part 4A of this RPDM.
  - Left out treatment
    - The need for an acceleration lane is to be determined based on a capacity and delay assessment for the movement, sight distance and other sight constraints.
    - The left turn treatment and any associated acceleration lanes are to be designed in accordance with Volume 3, Part 4A of this RPDM.
    - Where acceleration lanes are appropriate for this type of interchange, the length and cost will generally be significantly less than that associated with a conventional ramp.

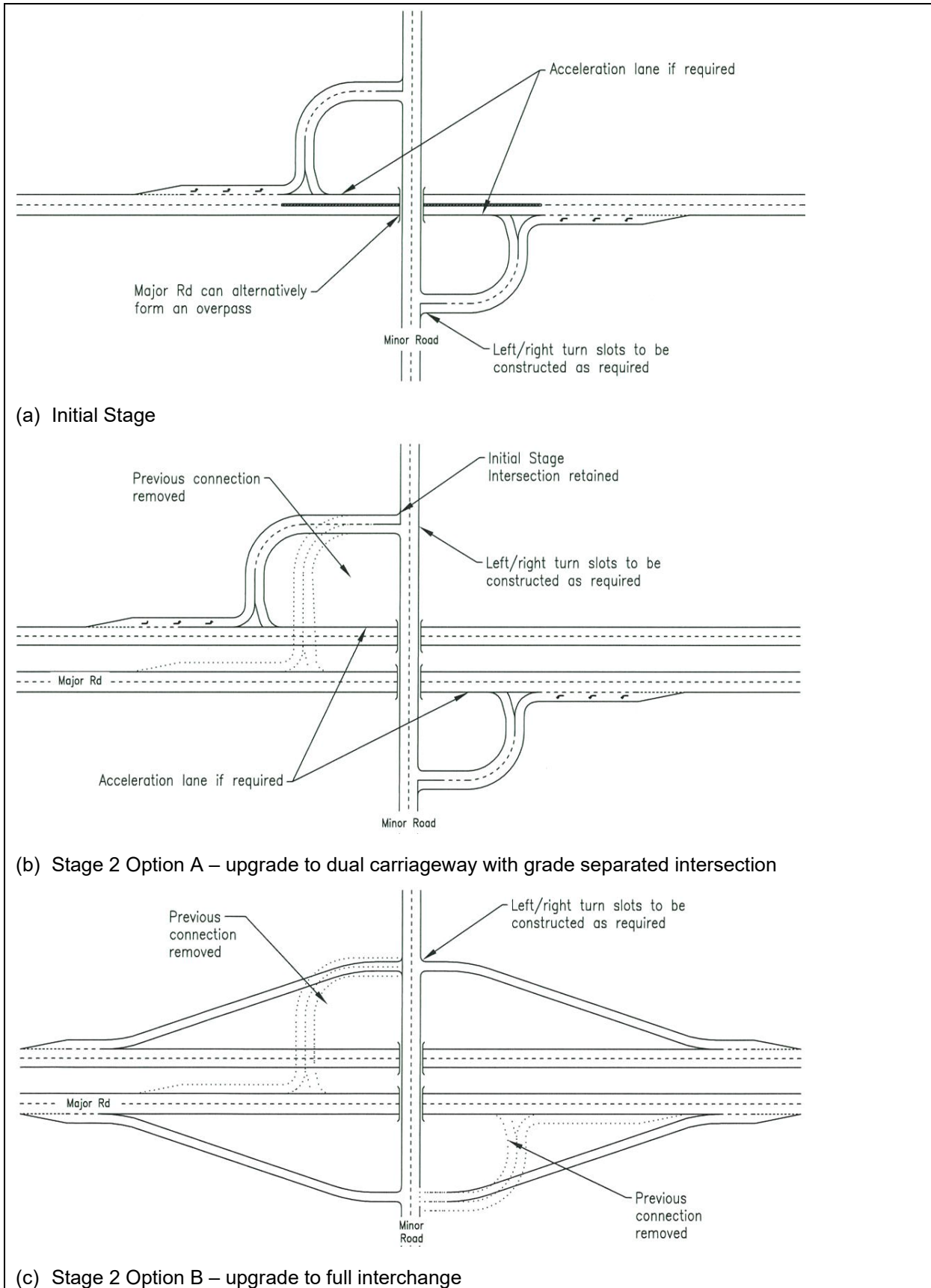
- No right turns or through movements across the major road at grade. These are restricted by physical measures such as median barrier, and
- Possibility to upgrade to dual carriageway on the major road or full interchange in the future. The intersections on the major and the minor roads, and the interconnecting road should be designed considering the location of any dual carriageway upgrade and/or ultimate ramps as part of a full interchange upgrade.

The advantage of grade separated intersections is that they provide most of the safety benefits from grade separation without full entry and exit ramps. There is also an increased flexibility at grade separated intersections to vary the quadrants of the intersection where the connecting roads are based to avoid high cost constraints. This reduces the cost and land requirement.

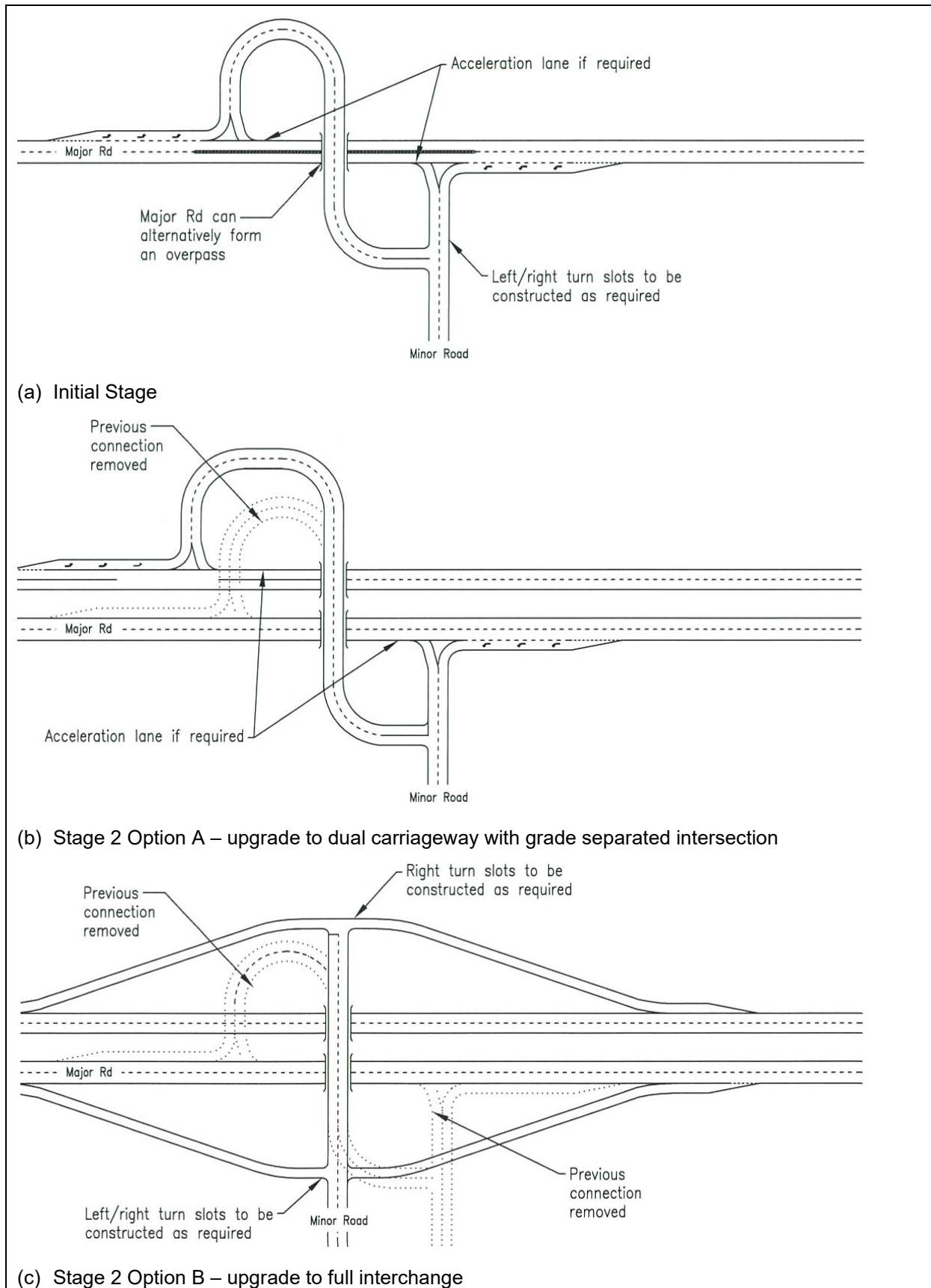
Grade separated intersections may be considered for high speed rural intersections with high crash rates where other intersection types are not appropriate. Grade separated intersections can also be used in urban areas. Motorways will still require full interchange design.

Examples of grade separate intersections are shown in Figures 4C-11 to 4C-13 illustrating the conceptual layouts for cross intersections and T junctions, and in Figure 4C-14 showing existing examples of grade separated intersections.

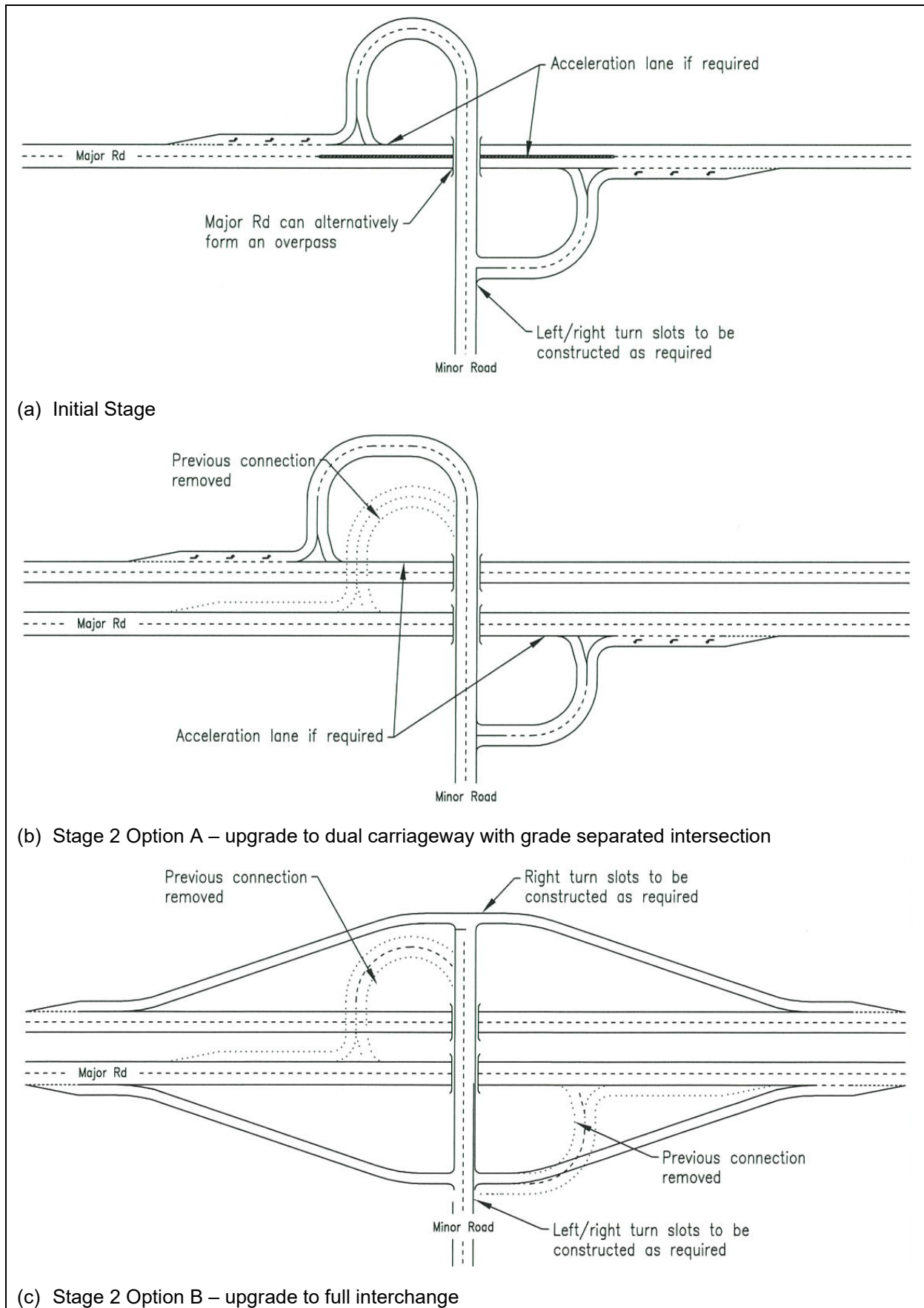
**Figure 4C-11 – Grade separated cross intersection**

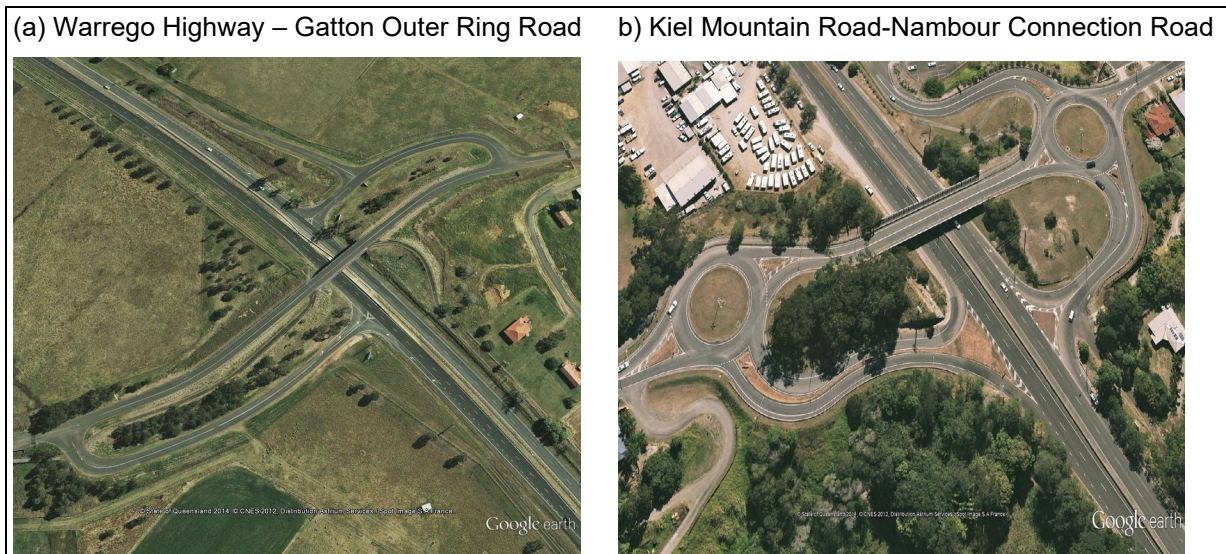


**Figure 4C-12 – Grade separated T-junction – Example 1**



**Figure 4C-13 – Grade separated T-junction – Example 2**



**Figure 4C-14 – Grade separated cross intersection examples on the network**

### 18.2 Grade separated movements

When at-grade intersections are near capacity, it may not always be economically practicable to further widen the intersection or to grade separate the entire intersection. A capacity analysis may reveal that removing a single movement, typically a right turn or through movement, through provision of a single movement ramp, can provide a substantial extension to the design life of the existing at-grade intersection. In some cases, intersections have had a second movement subsequently grade separated.

Grade separated right turn ramps can also be used where an additional intersection accommodating right turns is impracticable or undesirable. This may be due to proximity to other intersections or a desire not to introduce additional right turn conflicts on a major road. In these cases, the right turn ramp can allow for right turn movements to be accommodated at an otherwise left-in, left-out intersection.

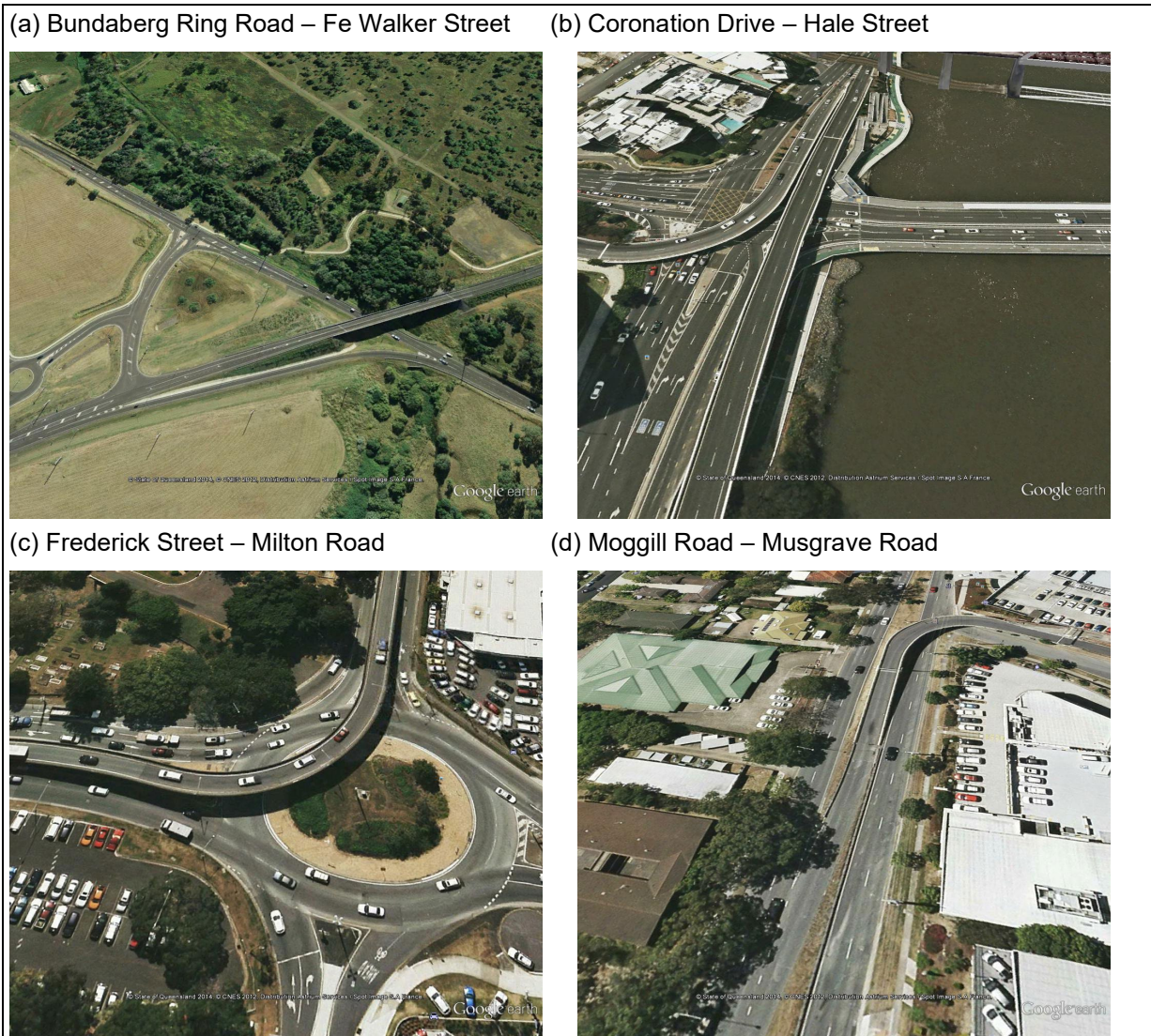
At these intersections, the grade separated right turn ramps can be a direct, semi-direct A or semi-direct B ramp. Other ramp types such as a loop or semi-direct C are typically not economical. The semi-direct A or direct ramp are acceptable for right turn movements only where the ramp is provided with its own dedicated lane on joining the exiting road.

The ramp diverge can be designed as a minimum treatment single lane exit.

- Length of diverge to be based on:
  - Diverge Length  $L = V W/3.6$ , or
  - Meeting the deceleration length requirements based on design speed of any curves on the ramp.
- Location of the physical nose is to be based on the provision of at least 7 seconds of visibility to the nose. The physical nose will require appropriate crash attenuation devices where a barrier is required in the nose due to the grade separation of the movements. An object height of 0.8 m is to be applied to crash cushions.

Ramps for through movements can be a flyover or underpass. Examples of grade separated movements are shown in Figure 4C-15.

**Figure 4C-15 – Grade separated movement examples on the network**



## References

Transport and Main Roads publication references refer to the latest published document on the departmental website ([www.tmr.qld.gov.au](http://www.tmr.qld.gov.au)).

### Additions

Austroads (2015) *Guide to Road Design Part 4C, Interchanges*, Austroads, Sydney, NSW

Austroads (2020) *Guide to Traffic Management Part 6, Intersections, Interchanges and Crossings Management*, Austroads, Sydney, NSW

Austroads (2020) *Guide to Traffic Management Part 3, Transport Study and Analysis Methods*, Austroads, Sydney, NSW

Transport and Main Roads *Cycling Infrastructure Policy*, Brisbane, QLD

Transport and Main Roads *Road Drainage Manual (RDM)*, Brisbane QLD

Transport and Main Roads *Road Landscape Manual*, Brisbane, QLD

Transport and Main Roads *Road Planning and Design Manual (RPDM)*, Brisbane, QLD

Transport and Main Roads *Manual of Uniform Traffic Control Devices (MUTCD)*, Brisbane, QLD

Transport and Main Roads *Traffic and Road Use Management Manual (TRUM)*, Brisbane QLD



## **Appendix C – Examples of ramp signal layouts**

### Additions

Additional guidance is included in Motorway Ramp Signalling Section of Section 8.4 of *TRUM Volume 1 – Guide to Traffic Management, Part 9 Traffic Operations*, via:

<https://www.tmr.qld.gov.au/business-industry/Technical-standards-publications/Traffic-and-Road-Use-Management-manual/Volume-1>

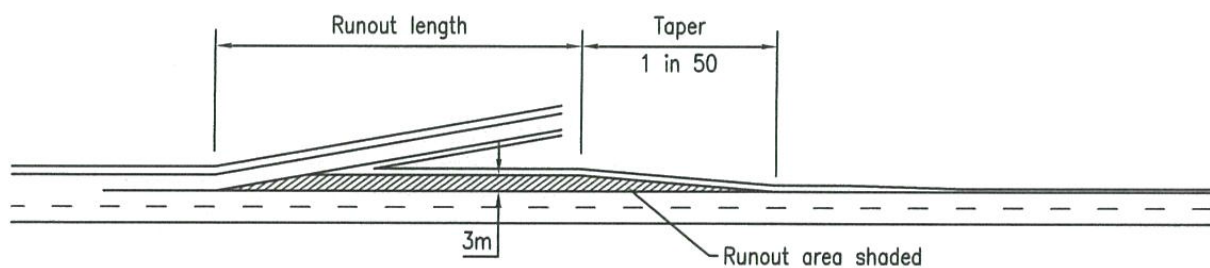
## Appendix D – Trapped lane exit – EDD treatment

There is no equivalent Appendix D in *Austroads Guide to Road Design – Part 4C*.

### New

Recently specialists in VicRoads have re-line marked a small number of existing lane drops past the exit to trapped lane exits or ‘Exclusive lane exits’ using their terminology. This is based on information that a trapped lane exit has a higher capacity than the exit where the lane drop occurs after the exit. There is anecdotal evidence that safety is not compromised. Therefore, when a lane drop after an exit is identified as a critical bottleneck, it has been converted to a trapped lane exit as shown in Figure 4C-D 1.

**Figure 4C-D1 – Trapped lane exit**



In these situations, a generous run-out area should be provided. The runout length should be 180 m minimum in length with the runout area similar to a pavement area for a lane drop as per Figure 11.5 in *Austroads Guide to Road Design – Part 4C*. Further signage and line marking is required before the exit to ensure that the trapped lane layout is very obvious to drivers.

Designers in Queensland may consider an EDD design based on this experience at critical bottlenecks. Specialist advice should be sought.

## **Commentary 5**

### **Additions**

The 1989 study on 'Urban Freeway Cycling' estimated that a cyclist requires a gap of 7 seconds in order to cross the ramp safely. It states that a maximum average delay of 15 seconds for cyclists is appropriate. This corresponds to a random traffic flow of 1000 vph. However, traffic counts for peak hours are an average, and volumes are higher at various times during the middle of this peak period. Consequently, an hourly peak traffic flow of 800 vehicles per hour is more appropriate, to allow for peak flows of 1000 vph in any part of the hour.

## Commentary 6

There is no equivalent Commentary 6 in *Austroads Guide to Road Design – Part 4C*.

### New

#### Determining the speed profile on deceleration ramps

This commentary can be used to determine the deceleration profile for an average and 85th percentile driver.

##### **Speed profile for an average driver**

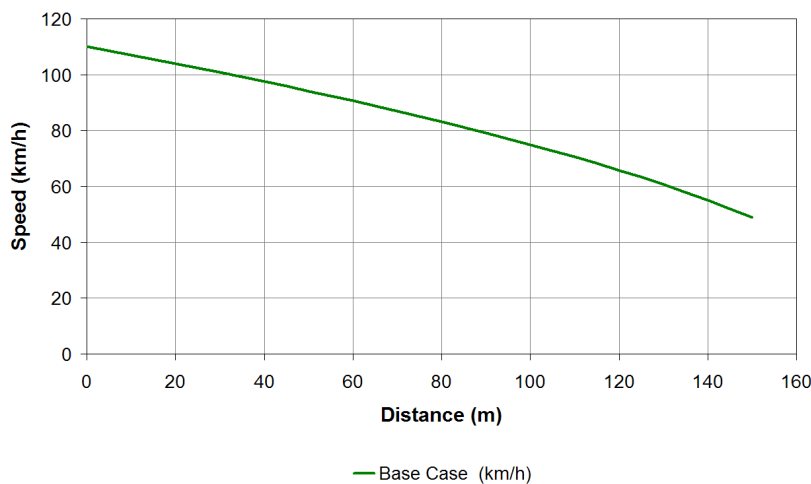
Deceleration rates on exit ramps are modelled using a constant rate of deceleration as shown in Figure 1 for an average driver. The speed profile is modelled by using the following equation of motion (Equation 1).

$$\text{Equation 1: } v^2 = u^2 + 2a_{\text{accel}}s$$

Where:

- $v$  = final speed (m/s),  $u$  = initial speed m/s
- $a_{\text{accel}}$  = acceleration (m/s/s) (negative for deceleration). The deceleration rate of an average driver can be taken as  $-2.5$  m/s/s. Note that this variable is normally represented as 'a', however a subscript has been added to differentiate it from the grade variable.
- $s$  = distance (m)

**Figure 4C-C6 1 – Average driver deceleration at constant deceleration rate**



Grade correction can be achieved by modifying Equation 1, by using the following relationship. This underlying principle of the relationship presented in Equation 2 is that the deceleration rate and impact of grade is represented as a proportion of acceleration due to gravity.

$$\text{Equation 2: } a_{\text{accel}} = -9.81(d + 0.01a)$$

Where:

- 9.81 = acceleration due to gravity (m/s<sup>2</sup>)
- $d$  = deceleration coefficient. (Positive for deceleration) The deceleration coefficient for an average driver is 0.25.
- $a$  = grade of the ramp (%); negative for downgrades, positive for upgrades.

Substituting Equation 2 into Equation 1, and making adjustments to convert the speeds into km/h, gives:

$$\text{Equation 3: } V^2 = \sqrt{U^2 - 254s(d + 0.01a)}$$

Where:

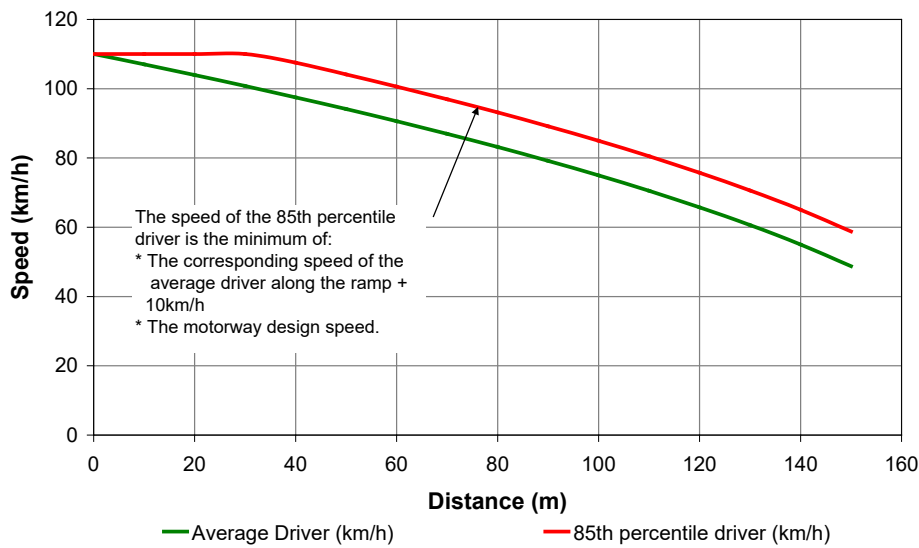
- V = final speed (km/h), U = initial speed (km/h)

**Speed profile for an 85th percentile driver**

The speed profile of the 85th percentile driver is determined by finding the minimum value of:

- the corresponding speed of the average driver along the ramp plus 10 km/h, and
- the motorway design speed.

**Figure 4C-C6 2 – Speed profile of the 85th percentile driver**



## Commentary 7

There is no equivalent Commentary 7 in *Austroads Guide to Road Design – Part 4C*.

### New

This commentary item aims to find a stopping sight distance equation which accounts for the fact that a driver is already decelerating on a deceleration ramp.

Before applying this equation, a designer must firstly establish the speed profile of an average and 85th percentile driver for normal exit ramp deceleration. Refer to Commentary 6.

After this, the designer is required to check sight distance to a hazard that might appear along the ramp. A designer may choose to use the conventional Stopping Sight Distance (SSD) equation (Refer to Equation 4). For constrained cases, this commentary shows the derivation of an alternative SSD equation which may be used during deceleration. Refer to Figure 4C-C7 1.

It is necessary to ensure that a driver travelling at the average speed has sight distance to a 0.2 m object. As a check, it is also necessary to ensure that a driver travelling at the 85th percentile speed has sight distance to a 0.8 m object.

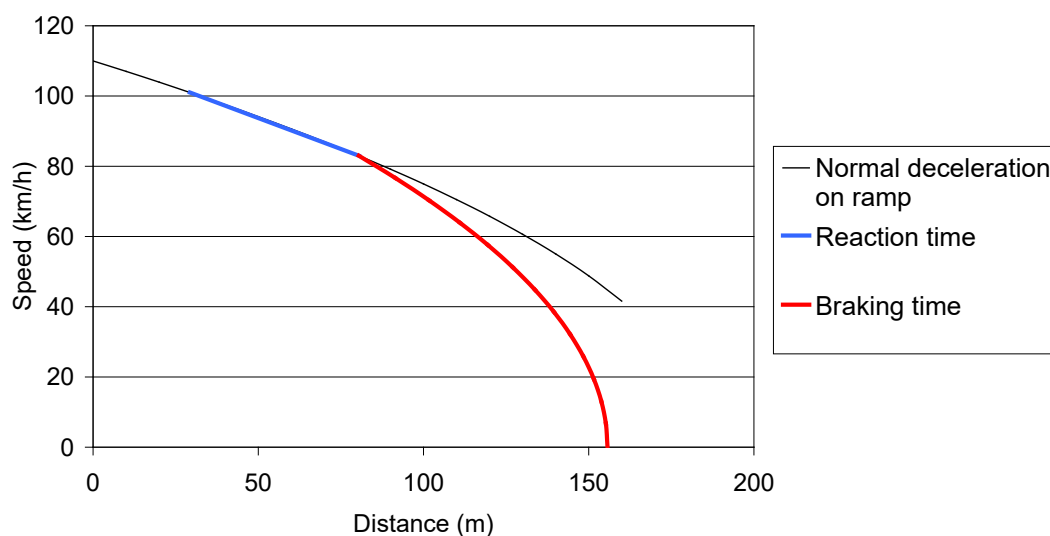
SSD = distance travelled during reaction time + distance travelled during braking.

$$SSD = \frac{R_T V}{3.6} + \frac{V^2}{254(d + 0.01a)}$$

Where:

- $R_T$  = Reaction time (sec)
- $V$  = Operating speed (km/h)
- $d$  = coefficient of deceleration (longitudinal friction factor)
- $a$  = longitudinal grade (% , + for upgrades & - for downgrades)

**Figure 4C-C7 1 – Example speed profile on a deceleration ramp when vehicle stops for a hazard**



Notes:

1. In this example, the normal deceleration on the ramp assumes that vehicles must decelerate from a mainline design speed of 110 km/h to a curve A speed of 44 km/h. Deceleration is constant and typically at a comfortable deceleration rate of  $-2.5 \text{ m/s}^2$ .
2. A hazard appears at a distance of approximately 30 m. Then a perception reaction time passes, while still continuing at the comfortable deceleration rate. Once the perception reaction time passes, the driver will begin to decelerate.

### Derivation

Firstly, isolate the reaction part of the equation:

- Prior to seeing an object on the road, drivers will be decelerating at a constant comfortable deceleration rate (typically  $2.5 \text{ m/s}^2$ ). Once the hazard appears on the road, drivers will need time to perceive and react. During this reaction time, drivers will continue to decelerate at their comfortable deceleration rate (again typically  $2.5 \text{ m/s}^2$ ).
- The speed at the beginning of the reaction time is  $V_1$ .
- The speed at the end of the reaction time (and beginning of braking time) is  $V_2$ .
- Since the deceleration is constant, the average of  $V_1$  and  $V_2$  may be taken as the speed during the reaction time.
- In the above equation (Equation 4), substitute for the average,  $V = \frac{V_1 + V_2}{2}$  in the reaction time part of the equation:

$$SSD = \frac{R_T \times 0.5(V_1 + V_2)}{3.6} + \text{Distance travelled during braking}$$

Now isolate the braking part of the equation:

- According to our definitions from above, braking begins at a speed of  $V_2$  – giving the following equation

$$SSD = \text{Distance travelled during reaction time} + \frac{V_2^2}{254(d + 0.01a)}$$

Now consider the entire equation together:

$$SSD = \frac{R_T \times 0.5(V_1 + V_2)}{3.6} + \frac{V_2^2}{254(d + 0.01a)}$$

- Derived from the following equation of motion ( $v = u + a_{\text{accel}}t$ ), where “a” is acceleration (negative for deceleration). Note a subscript has been added to the acceleration variable to differentiate it from the grade variable.

$$\begin{aligned} \frac{V_2}{3.6} &= \frac{V_1}{3.6} + a_{\text{accel}} R_T \\ V_2 &= V_1 + 3.6 \times a_{\text{accel}} R_T \end{aligned}$$

- Now substitute  $V_2$  from the previous equation and simplify to give Equation 5:

$$SSD = \frac{R_T \times 0.5(V_1 + V_1 + 3.6 \times a_{\text{accel}} R_T)}{3.6} + \frac{(V_1 + 3.6 \times a_{\text{accel}} R_T)^2}{254(d + 0.01a)}$$

Equation 5:

$$SSD = \frac{R_T V_1}{3.6} + 0.5 a_{accel} R_T^2 + \frac{(V_1 + 3.6 \times a_{accel} R_T)^2}{254(d + 0.01a)}$$



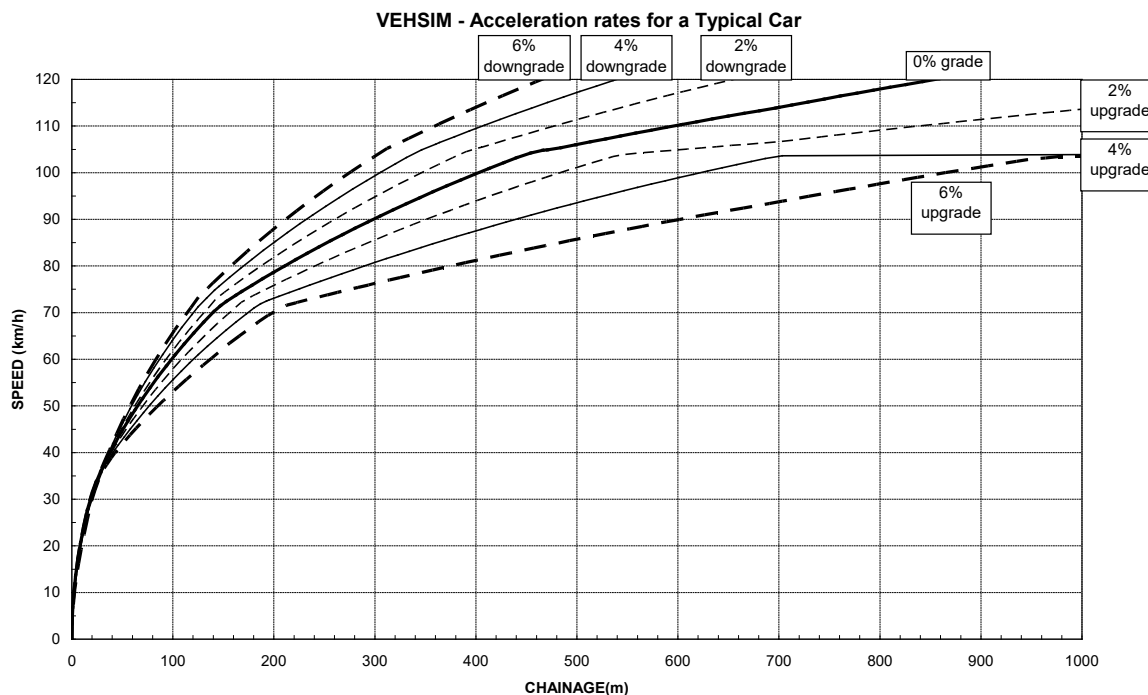
## Commentary 8

There is no equivalent Commentary 8 in *Austroads Guide to Road Design – Part 4C*.

### New

The tables for determining the acceleration length required on motorway entry ramps are based on the results from VEHSIM modelling for a typical car. The output acceleration profiles from this modelling are shown graphically in Figure 4C-C8 1.

**Figure 4C-C8 1 – VEHSIM acceleration speed profiles on an on-ramp**



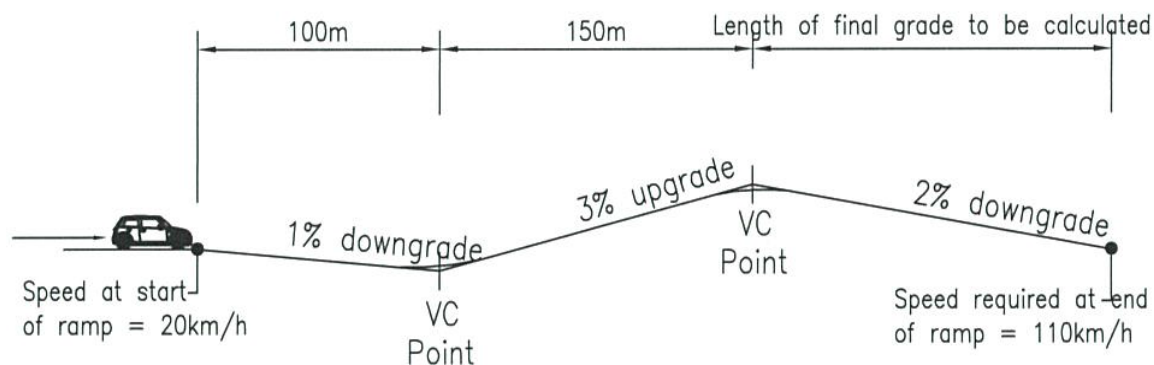
The curves shown in Figure 4C-C8 1 can be used to determine acceleration lengths for ramps with characteristics not covered by the Tables in Section 11.3.3.

These curves can also be used to determine the acceleration profile on ramps with compound grades (i.e. ramps consisting of sections of varying grade). These are determined by tracking the acceleration profile along each grade curve for the length of each section of grade as demonstrated in the following example.

### **Example calculation for a ramp with multiple grades**

In this example, the features of the ramp entry to a motorway are as follows and as shown in Figure 4C-C8 2:

- Entry curve at the start of the ramp restricts traffic speeds to 20 km/h.
- Immediately following the curve the ramp is a 1% downgrade for a length of 100 m. The ramp then continues as a 3% upgrade for a length of 150 m and finishes as a 2% downgrade to merge with the motorway.
- The design speed at the merge with the motorway is 110 km/h.

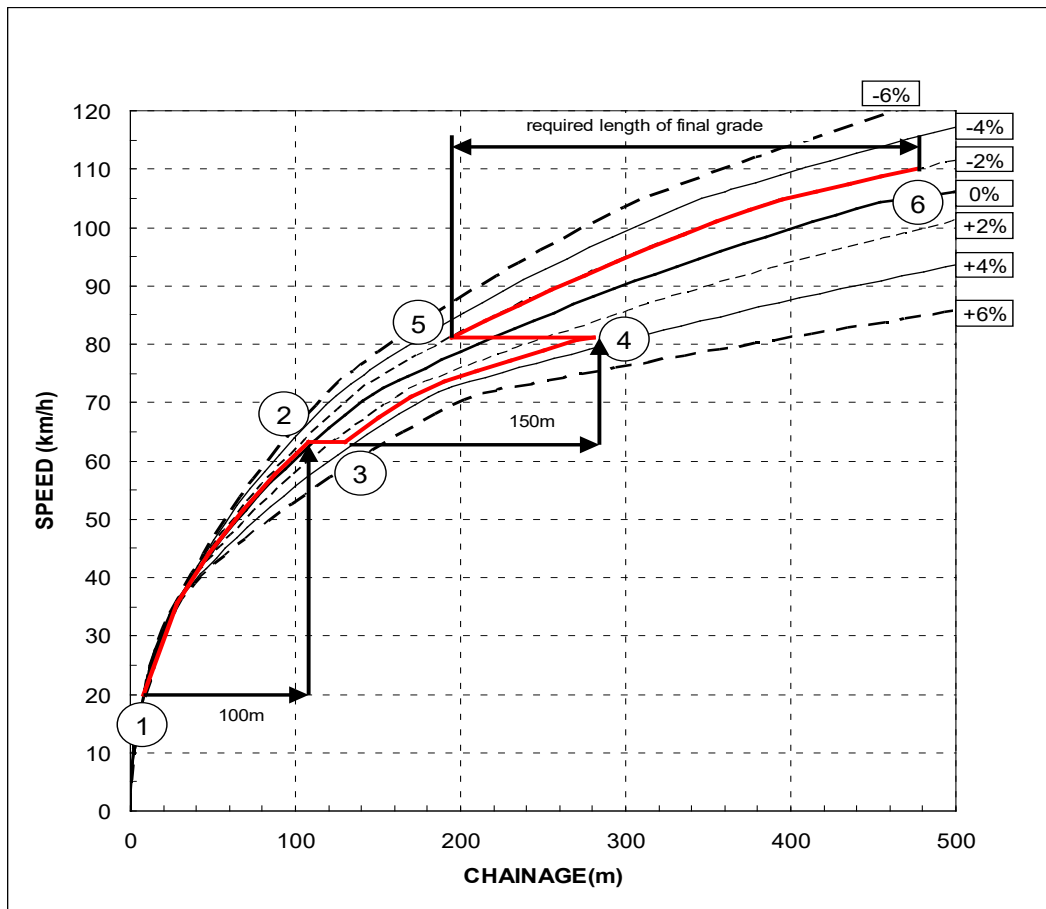
**Figure 4C-C8 2 – Example ramp with multiple grades**


The process to determine the required length of the entry ramp is as follows. Each point in the table below refers to the circled number on Figure 4C-C8 3.

**Table 4C – C8 1 - Using the VEHSIM acceleration curves to establish ramp lengths for ramps with compound grades**

Point	Input	Calculation / comment
1	Entry speed at the start of grade 1 = 20 km/h	Identify the chainage at 20 km/h on 1% downgrade line = 8 m.
2	The length of grade 1 = 100 m	Chainage at end of grade 1 on 1% downgrade line = 8 m + 100 m = 108 m. Find the speed at chainage 108 m on the 1% downgrade line = 63 km/h.
3	Entry speed at the start of grade 2 = 63 km/h	Find the chainage at 63 km/h on 3% upgrade line = 130 m.
4	The length of grade 2 = 150 m	Chainage at end of grade 2 on 3% upgrade line = 130 m + 150 m = 280 m. Find the speed at chainage 280 m on the 3% upgrade line = 81 km/h.
5	Entry speed at the start of grade 3 = 81 km/h	Find the chainage at 81 km/h on 2% downgrade line = 195 m.
6	Design speed required at end of grade 3 = 110 km/h	Find the chainage where 3% downgrade line crosses 110 km/h speed = 477 m. Length of grade 3 = 477 m – 195 m = 282 m.

**Figure 4C-C8 3 – using the VEHSIM acceleration curves to establish ramp lengths for ramps with compound grades**



The results of this analysis indicate that the final section of the ramp should be at least 282 m in length to ensure that vehicles on the ramp can enter the motorway at the design speed of 110 km/h. The speed profile along the ramp is shown in Figure 4C – C8 4.

**Figure 4C-C8 4 – Vehicle speed profile**

